



Winning with extraordinary people



KPMG P/S Annual Report

1 October 2017 – 30 September 2018

kpmg.dk

CVR no. 25 57 81 98

KPMG P/S
Dampfærgevej 28
2100 København Ø

The annual report was presented and adopted at the Company's annual general meeting on 30 January 2019.

Anticipate
tomorrow
Deliver
today

CONTENTS

Management's review	3
Company details and financial highlights	4
Winning with extraordinary people	5
Fostering a high-performing and innovative workplace	13
Making a difference in our communities	19
Diversity and Inclusion	25
Using data to secure confidence and trust in a digital age	30
Entering the era of New Practice	39
Building the public sector of tomorrow	45
Empowering business through technology	52
Driving digital value for CFOs	55
Advanced analytics in mergers and acquisitions	58
Improving cyber security and compliance with GDPR	59
New technologies make tax transparent and responsible	61
Statement by the Board of Directors and the Executive Board	67
Independent auditor's report	69
Financial statements 1 October 2017 – 30 September 2018	73
Income statement	74
Balance sheet	74-75
Statement of changes in equity	75
Cash flow statement	75
Notes	77

Management's review

Company details

KPMG P/S
Dampfærgevej 28
2100 København Ø

Telephone: +45 70 70 77 60
Website: www.kpmg.dk
E-mail: kpmgdanmark@kpmg.com

CVR no.: 25 57 81 98
Established: 11 December 2013

Financial year: 1 October – 30 September

Board of Directors

Anette Harritz (Chairman)
Anja Bjørnholt Lüthcke
David Olafsson
Bo Johansen
Danny Golan

Executive Board

Thomas Hofman-Bang

Auditor

Redmark
Statsautoriseret Revisionspartnerselskab
Dirch Passers Allé 76
2000 Frederiksberg

Financial highlights

DKK'000	2017/18	2016/17	2015/16	2015 9 months	2013/14
Key figures					
KPMG in Denmark Revenue*	697,144	575,358	491,377	279,056	103,187
Revenue KPMG P/S	507,568	424,003	368,832	205,451	63,200
Profit/loss from financial income and expenses	-707	993	759	-2,480	-7,912
Profit for the year	0	0	0	0	0
Total assets	202,208	239,026	257,703	275,567	215,487
Investment in equipment and leasehold improvements	5,880	2,052	13,964	15,649	5,070
Equity	627	560	560	560	500
Cash flow from operating activities	30,706	-12,388	42,677	-21,633	22,291
Cash flow from investing activities	-7,353	-3,363	-13,990	-20,996	-13,025
Cash flow from financing activities	-25,798	-649	-5,614	19,128	16,649
Total cash flow	-2,446	-16,400	23,073	-23,501	25,915
Operating margin	0.1%	-0.2%	-0.2%	1.2%	12.5%
Current ratio	89.3%	92.1%	92.2%	88.6%	94.5%
Return on equity	0.0%	0.0%	0.0%	0.0%	0.0%

*KPMG P/S and Acor Tax P/S

Financial ratios are calculated in accordance with the Danish Society of Financial Analysts' guidelines on the calculation of financial ratios "Recommendations and Ratios". For terms and definitions, please see the accounting policies.

Our results for the financial year reflect our economic condition: our continued strong growth and the decreased need for provision of financial support by KPMG International. We have incurred costs in relation to our organic and continued growth, especially in regard to our hiring processes, attracting new talents and further investing in our tools and structures. These investments ensure the expanding delivery of high-quality services to our clients. This year's revenue is in line with our goals, and our net result is as expected given the support we receive from KPMG International.

Winning with extraordinary people

2018 was a strong year for KPMG in Denmark achieving a total revenue growth of 21.2% across Audit, Advisory and Tax. We are proud that KPMG – once again – is the fastest growing professional services firm in Denmark among the Big Four based on organic growth.

Overall revenue increased from DKK 575 million in 2016/17 to DKK 697 million in 2017/18. KPMG experienced growth across all business areas with Audit accounting for 6.2%, Advisory 28.3% and Tax 25.3%. We are grateful for being the clear choice for our clients and that our services are so well received in the marketplace.

Our success is driven by our extraordinary people

As the fastest growing professional services firm, we need extraordinary people. We have more than 600 passionate and highly skilled specialists within Audit, Advisory and Tax. With an average age of 34, most our employees are digital natives, and as a truly international organisation, our workforce consists of over 26 nationalities.

Our employees are key to our future success. Each year, we conduct a people survey to improve our efforts and make sure our employees stay engaged. We are therefore pleased to see that 84% are satisfied with the learning and development we offer. It is an increase from 70% in FY17 ranking KPMG 15 percentage

points higher than the global norm for professional services firms.

Our successful journey is also reflected in our market activities. In 2018, KPMG made a significant leap in the annual brand image analysis from Berlingske Business, jumping 36 places among the strongest brands in Denmark to position 56 out of 140 leading companies. Our talented employees are mentioned as a key strength among respondents.

From best practice to New Practice

A global technology race is taking place with significant ramifications. The winners in the coming years are the companies that succeed in embracing a new digital mindset and understand the implications of the exponential growth of data and the proliferation of artificial

intelligence and automation. Companies can no longer rely solely on best practice to stay ahead and need a fundamentally different approach. We call it New Practice and provide a strategic business framework and the implementation of the whole spectrum of AI-based technologies.

In FY18, we experienced a strong demand for our New Practice services from a wide range of clients and industries such as Egmont, Nykredit, TDC as well as major international clients within the pharmaceutical, energy and financial services sectors.

We combine our New Practice approach with our ability to work efficiently across regions with other KPMG member firms. For example, we successfully delivered, rolled out and

implemented advisory services globally for the Rockwool Group in FY18, empowering customer excellence and digitalising the full agenda of Customer Relationship Management. KPMG also helped industry-leading hearing aid company Widex design new efficient data management processes across its global organisation.

Significant wins across Denmark

During FY18, KPMG achieved significant audit wins. In the large clients segment, we won the audit of Royal Unibrew, LM Wind Power and Total E&P Denmark as well as Dansk Undergrunds Consortium (Danish Underground Consortium). We expect the trend to continue in FY19 due to the EU audit reform, which is starting to gain momentum.

In parallel, we assisted the many growth companies across Denmark, which constitute the backbone of the Danish economy, from our offices in Copenhagen, Aarhus, Kolding and Aalborg. We had a solid mid-market footprint and grew our base of national mid-market clients by approximately 25% over the past year. Our main focus in the mid-market is on innovative start-up companies, fast-growing companies and family-owned businesses.

We are deploying advanced data and analytics tools to perform efficient audits and provide valuable insights to our clients. By using KPMG Clara, our data and analytics tool, our audit teams are able to analyse and apply their judgement to entire data populations and sets of transactions instead of only on selected samples.

This means that we get audit evidence, resulting in high-quality audit. Furthermore, we established a KPMG Innovation Lab in FY18, which we use to inspire, co-create and ignite new ideas and solutions together with our clients.

Increased regulations for companies

KPMG has several clients within the financial services sector, including large insurance companies and Banks such as Codan, Trygg-Hansa, If, Skandia, Jyske Bank and Nordea. In FY18, we assisted our clients with different challenges such as the implementation of the new international financial reporting standards IFRS 9 and IFRS 17, performed financial due diligences and provided advice on the new regulatory capital requirements, advising on anti-money-laundering, and providing assistance in connection with change of core IT systems.

Transparent tax with technology

Together with our clients, KPMG utilise the best tax technology to gain significant insights by leveraging tax data analytics. We have for example developed tax robots to streamline our internal processes.

During FY18, we experienced a strong demand for our outsourcing and tax consulting services and secured new major wins as an outsourcing partner for several global tax compliance and reporting services for Danish-headquartered multinationals.

In addition, tax dispute resolution is an area for which we are

foreseeing further growth due to complexity in legislation and continued increase in cross-border transactions.

Powerful alliances

KPMG has strong alliances with Microsoft, Google and Amazon Web Services. During FY18, we experienced an increased demand in helping clients transform their businesses and operating models with secure cloud computing, machine learning, enterprise mobility and advanced analytics technologies.

The cloud is a driving force behind technological disruption affecting every organisation and making it critical for businesses to commit themselves to transform and remain relevant. As they adapt to change, our clients adopt the cloud to boost agility, increase speed to market, reduce costs and strengthen security.

Furthermore, we have impactful alliances with Blue Prism, providing our clients with a more agile virtual workforce through the use of robotic process automation and Coupa which enhances our ability to help clients transform their Procure-to-Pay processes.

Igniting growth among start-ups

We recognise the importance of fostering ecosystems that will bring us tomorrow's great ideas both for companies and society as a whole. This is why we have a strong presence in start-up communities among universities and educational facilities offering free counselling on how to set up a business with the potential to prosper.

KPMG sponsors and partners with a number of festivals and foundations aiming at strengthening the innovation in Denmark and igniting potential.

Throughout the year, we supported Danish Tech Challenge, arranged by The Danish Industry Foundation (Industriens Fond), Greentech Challenge, a competition for start-ups with environmental ambitions backed by the Confederation of Danish Industries (DI) and TechBBQ, Denmark's largest innovation summit and tech festival, bringing over 16,000 tech-interested people to Copenhagen in 2018.

Trust and quality in times of uncertainty

We have an unwavering commitment to quality and know that we must uphold the highest possible standards in order to build and maintain public trust.

Our quality strategy begins with a relentless focus on quality and further guides us to continuously improve quality and consistency. Only the best is good enough – it is our duty to the public and the capital markets.

Responsibility for quality starts at the top and means driving and reinforcing accountability through the complete chain of command in all our teams and service lines so that every action helps us meet our rigorous quality objectives.

KPMG in Denmark earned trust from our clients and the market, who want to do more business with us, our skilled people who want to work for us – and last but not least – the regulators.

The Danish Business Authority (Erhvervsstyrelsen) published their report on quality control inspection at KPMG in 2017 without any critical comments or improvement areas for our quality control system. Our Transparency Report which will be issued on 30 January 2019 discloses more information about our quality control system.

Diversity and inclusion is a key priority

We value diversity and provide equal opportunities to all genders regardless of background in recruitment and promotion processes, which is strongly recognised by our employees in our annual people survey.

In FY18, we increased the promotions of women by 10%. Overall, 35% of all promotions were women, which reflect our commitment to provide equal opportunities in KPMG.

Today, 38% of all our employees are women, and we are proud to have supported women in their efforts to attain higher positions and that they represent 40% on our Board of Directors.

Our new Global Inclusion and Diversity Strategy guides us to ensure that we put our priorities into practice. Today, our top management level consists of eight people, of whom five are men and three are women, corresponding to a total of 38% women.

We are proud to have a balanced gender representation on our Board and in top management. At the same time, we continue to strive for further advancement across all management and staff levels.

Making a difference in our local communities

At KPMG, both in Denmark and globally, one of our core values is to improve our communities, and we are deeply committed to achieving this by making a positive impact in our communities and the environment through the work we do.

Since 2002, KPMG has been a signatory to the United Nations Global Compact (UNGC), which means we monitor our impact on and work to create positive contributions within human rights, labour rights, the environment and anti-corruption.

In FY18, we focused on strengthening our partnership with Mind Your Own Business, where KPMG mentors help teenagers of ethnic minorities from exposed areas to build their own micro companies.

We also stepped up our involvement in the KPMG Global Security Day, an initiative to reach out to pupils across the world and empower them to navigate online in a safer and more informed way. KPMG firms from 46 countries including Denmark collaborated on bringing Cyber Security Awareness Month on the agenda across the world and increasing cyber safety among youth.

Accelerating towards ONE in 22

Last year, we launched an ambitious strategy called ONE in 22. Our continued growth in FY18 reflects that our strategy continues to be impactful.

Key focus areas are:

- our ability to work seamlessly across our organisation as One Firm
- becoming the market leader in selected market areas by working shoulder to shoulder with our clients and compiling the right teams with diverse capabilities
- and last but not least, reaching a revenue of DKK 1 billion no later than 2022.

During FY19, Thomas Hofman-Bang, who has been our CEO since 2014, will step down, and we thank him whole-heartedly for his leadership during which he, together with the partner group and our extraordinary people, has put KPMG in Denmark back on the map. His successor, Henrik R. Mulvad, will take over a company fit for sustainable growth and continue our growth journey.

Reaching for success in FY19

With yet another strong year for KPMG in Denmark, we take the market's positive response to our offerings as an encouragement to continue our successful path working shoulder to shoulder with our clients and help them to successfully transform and take the lead in a digital world.

We expect continued growth in FY19 and are looking forward to developing and implementing new innovative solutions to meet our clients' key challenges. With dedicated and extraordinary people as the backbone of our success, we will be reaching for continued success in FY19.



Principal activities and financial position

Principal activities of the Company

Our principal activities are the provision of professional services to Danish and foreign businesses within the technical expertise areas of audit and advisory services. We do this across a wide and growing range of services, including the audit of financial statements, other assurance engagements, management consulting, risk consulting, deal advisory and tax services.

Operational risk

The operational risks facing our business include those we have in common with other professional services firms. This is notably a deterioration in market conditions, claims and reputational damage caused by either an actual or a suspected failure to deliver services of appropriate quality, or by taking on inappropriate clients or engagements. We have implemented a system of quality control based on KPMG International's Quality Framework, and we regularly conduct enterprise risk assessments where we identify potential risks and their impact on our business. Based on that, we plan remediating actions as well as quality performance and risk

compliance reviews. Our Transparency Report which will be issued on 30 January, 2019, describes the key elements of our quality control system. We are committed to consistently achieving the highest standard of quality, ethics and integrity in our day-to-day activities as a responsibility we bear to our clients, regulators, communities and capital markets. Find the Transparency Report on our website, www.kpmg.dk.

Financial risk

We are exposed to credit risk though we do not have any material credit risk on individual debtors.

Events after the balance sheet date

No events have occurred after the balance sheet date that could significantly affect the financial statements for 2017/18.

Increase in revenue

■ KPMG P/S
 □ KPMG ACOR TAX P/S

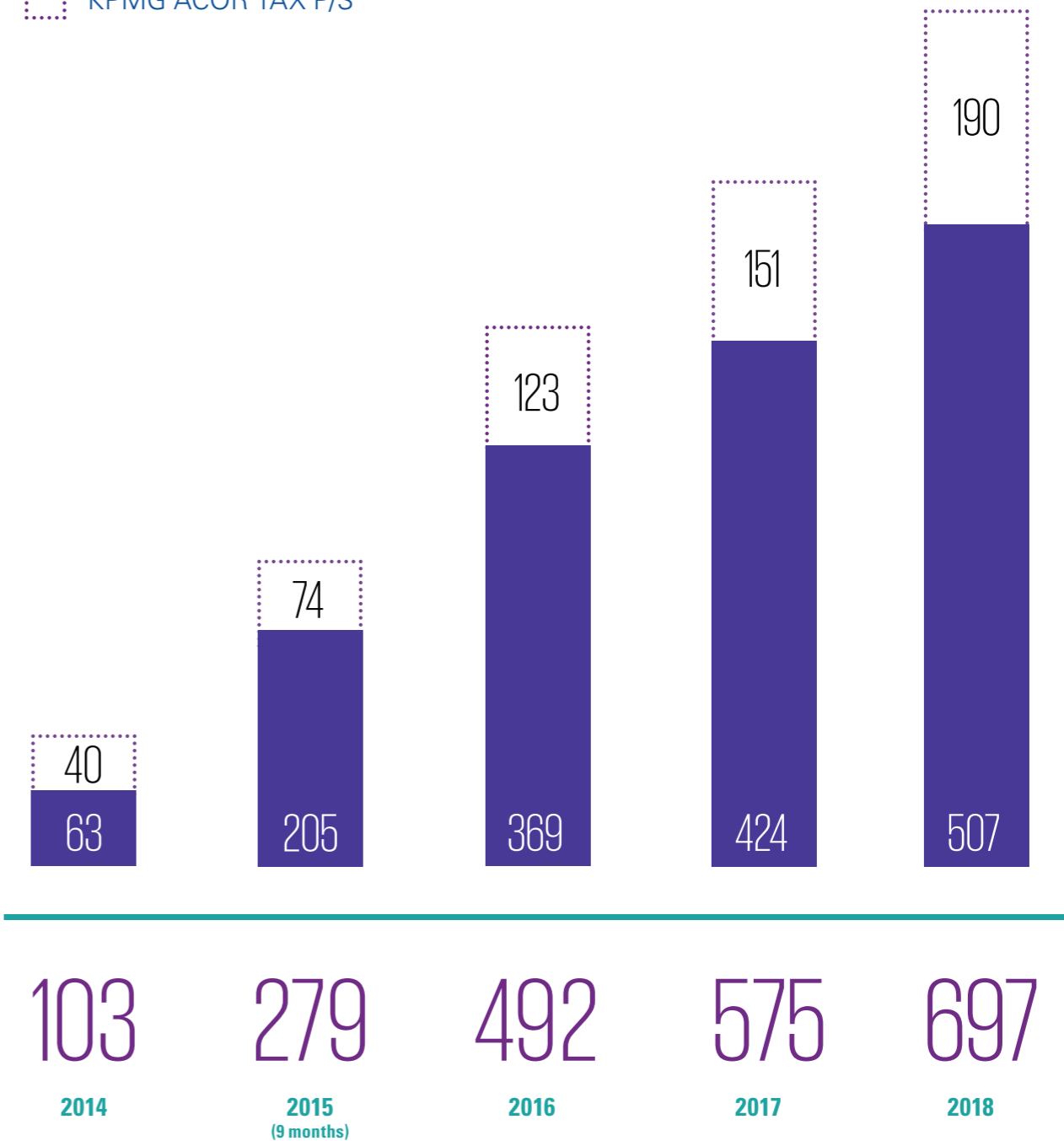

Combined revenue of KPMG P/S and KPMG Acor Tax P/S, DKK million

Our Global network

KPMG is a global network of professional services firms providing audit, advisory and tax services. We operate in 154 countries and have 200,000+ people working in member firms around the world. We work closely with a broad range of clients, such as business corporations, governments and public sector agencies and not-for-profit organisations. We support them in mitigating risks and exploiting business opportunities.

200,000+

Global number of employees



29

Combined global revenue USD billion



7.1%

Global revenue growth rate



154

Countries in which member firms operate



About KPMG in Denmark

In Denmark, KPMG is organised in two separate legal entities that provide services through a cross-functional collaboration between KPMG P/S (licence to provide audit and advisory services) and KPMG Acor Tax P/S (licence to provide tax services).



634

Total no. of employees and partners

62% ♂

Men

38% ♀

Women



697

Combined revenue DKK million



21.2%

Local revenue growth rate



224

Total no. of employees and partners onboarded

Fostering a high-performing and innovative workplace

At KPMG, our focus is at all times to attract, retain and develop employees who will thrive in a high-performing and fast-paced environment. With an average age of 34, our employees are digital natives and we embrace innovation as part of our DNA. We value our employees' opinions and act to foster an inclusive and stimulating work environment. Our yearly people survey is an important tool to measure how we are progressing in relation to our key priorities. Therefore, we are pleased to see that our overall engagement score increased from 76% to 84% in FY18 – significantly above the global professional services norm of 76%.

The key to our future success

During the past years, we have established a solid learning and development environment at KPMG acknowledging that the continuous development of our employees is key to our future success. Therefore, it is highly appreciated that our employees recognise these efforts in FY18. 84% are satisfied with the learning and development we offer – an increase from 70% in FY17, which ranks KPMG 15 percentage points higher than the Danish norm across industries.

This year's people survey also very clearly demonstrated that people are proud to work for KPMG. 90% of respondents answered yes to this

question, and after nearly five years of hard efforts to re-establish our name and employer brand, we are extremely proud to see our employees express such a significant dedication to our firm. The result is 3 percentage points ahead of the Danish norm across industries. 72% also experience support in their efforts to balance work and personal life, which is an increase from 60% last year. Going forward, we aim to improve even further on the work-life balance by giving our employees a flexible work environment and the tools and structures to support this.

Digital front runners in our market

At KPMG, we aim to be digital front runners in our market. We have initiated numerous initiatives, among others a Digital Portfolio Team responsible for the KPMG Digital Strategy. We have not yet seen the full potential and result of this. However, we are pleased to see a significant increase in people saying that KPMG has established an innovative climate where one can challenge the status quo. The increase from 75% to 84% is significantly above the Danish norm across industries of 76%, and a result we expect to increase further at KPMG over the coming years.

26
Nationalities

41%
Increase in graduates

34
Average age

44
Graduates on Future Focus Programme

11
Audit trainees

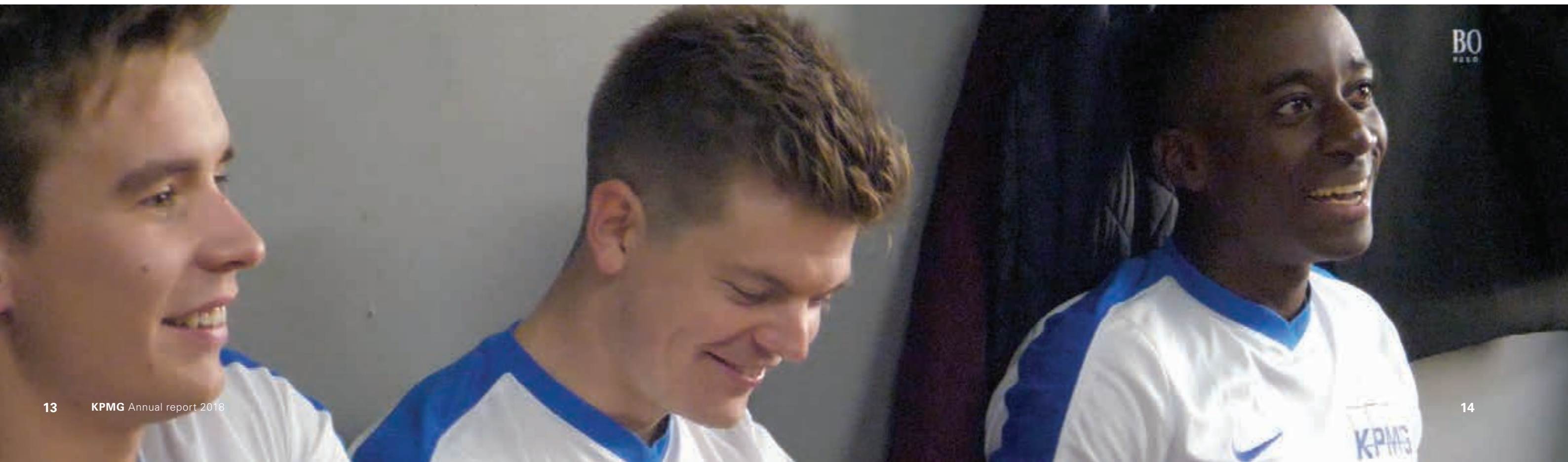

“ I like that we are challenged to be bold. When working with cutting-edge AI technologies, we are empowered to work autonomously and to find solutions that bring the most value to our clients.

Arash Afsarian,
Head of NewTech Strategy, Advisory

“ I enjoy being part of a professional services firm with a global reach and the possibilities it entails. I get to work with fun and challenging projects and collaborate with teams all around the world!

Mikkel Kjærsgaard,
Manager, Deal Advisory



“ I work with diverse colleagues and help them develop and thrive every day. At KPMG, we are fostering a culture where the individual is valued and respected, and it is great to be a part of that.

Jane Nørgaard Jørgensen,
HR Business Partner, HR

“ No two days are the same. KPMG is such a dynamic place to work, which only confirms my choice of staying here after graduating university.

Khawla El Mekkaoui,
Assistant, Audit

“ As auditors at KPMG, we are trusted with a high degree of responsibility, and I can be sure that my ideas, concerns and suggestions for improvement are always heard.

Rie Larsen,
Senior Manager, Audit

Exceptional colleagues can do exceptional things

We want to create a learning environment where our exceptional colleagues can do exceptional things. We are actively working on the implementation of digital technologies to develop cutting-edge blended learning solutions through the use of artificial intelligence and robotic process automation. The training curriculum for 2018 was expanded with the roll-out of new courses focusing on behavioural change management, robotics, virtual reality and artificial intelligence.

In FY18, we also launched a brand new 2-year programme designed to develop our business administration students to become first-class auditors. Following hot on the heels of this, we welcomed 55 graduates and trainees, receiving more

than 1,000 applications from graduates applying for the Future Focus graduate programme. This year, graduates headed to Budapest in Hungary for training and networking, while our trainees went to Berlin.

Enhancing and building current leadership abilities

Great leaders move us and inspire us to do our best work. It is therefore important that we have authentic and effective leaders that empower and influence their staff to achieve business and team goals. In FY18, we initiated a number of development programmes to enhance and build on current leadership abilities. Among those initiatives are a Performance Manager Development programme and a Partner Development programme.



“ The onboarding programme to Berlin was a fantastic start to my career at KPMG. It was clear to me that I had just joined an organisation that is willing to invest a lot in my future with them.

Patrick Adelsparre,
Trainee, Audit

“ I am a big believer in education. The Commercial Academy at KPMG offers courses that help me develop and grow in my current role and support my future aspirations. It sharpens my ability to deliver a great client experience.

Nynne Bates,
Manager, Advisory





Making a difference in our communities

At KPMG, both in Denmark and globally, one of our core values is to improve communities, and we are deeply committed to making a positive impact in our communities and environment through the work we do. In 2018, KPMG's contribution to our local communities included more than 600 pro bono hours. KPMG strives to ignite the potential within our clients, but also in our communities, which we do in numerous ways.

Helping green start-ups to succeed

As a proud sponsor of the Greentech Challenge, KPMG is actively involved by offering pro bono auditing as well as advising on setting up business models to sustainable start-ups that will help their ideas prosper and become financially sustainable as well.

“ For many of our green start-ups, KPMG's forward-thinking advising on accounting has proven vital for their business models and ability to grow.

Frederik van Deurs,
CEO, Greentech Challenge

Supporting young entrepreneurs

In 2018, we focused on strengthening our partnership with Mind Your Own Business and the KPMG Global Cyber Security Day initiative. The Mind Your Own Business Academy supports at-risk teenagers

from vulnerable areas in building their own micro companies with support from mentors. KPMG helped establish this programme in 2016, and is now the key corporate partner of the third season of the programme. In FY18, KPMG significantly increased its contribution to Mind Your Own Business as 18 KPMG mentors (compared to eight in 2017) are now supporting five micro companies (compared to three in 2017).

The KPMG mentors are assigned to a specific micro company for a period of eight months and help the company grow through mentoring and workshops. This includes a full-day goal-setting session for all micro companies hosted by KPMG, as well as subsequent workshops tailored to each micro company. Finally, and most importantly, the programme allows for mentoring on other aspects of life besides those related exclusively to the micro companies.

“ In the role as business mentors, KPMG employees help the boys develop both professionally and socially through cooperation. We highly appreciate the authentic and professional cooperation with KPMG.

Maria Kavita Nielsen,
CEO, Mind Your Own Business



Educating a new generation of internet users

As online privacy is under pressure and ethical limits are being challenged, it is important to inform the new generation of internet users, so they can become responsible and reflected online citizens that will influence the internet communities in a positive direction.

In 2018, we stepped up our involvement in the KPMG Global Security Day, an initiative to reach out to pupils across the world and empower them to navigate online in a safer and more informed way. A team of dedicated KPMG employees engaged with students from grades 5-7 at a number of Danish schools, teaching and debating the threats and risks related to online activities and how to mitigate them.

KPMG firms from 46 countries including Denmark collaborated on bringing Cyber Security Awareness Month on the agenda across the world and increasing cyber safety among youth, making a positive difference.

“ Although the children know a lot about the Internet and about the obvious pitfalls, they still have a lot to learn. Through KPMG's involvement, we picked up a lot of tips on how we hopefully in future can avoid some of the online risks.

Lene Andersen,
Department Leder, Stenløse Privatskole

Signatory to the United Nations Global Compact

Since 2002, KPMG has been a signatory to the United Nations Global Compact (UNGC), and as part of this commitment, KPMG follows and reports on our progress within the 10 principles covering human rights, labour, environment and anti-corruption. KPMG in Denmark follows and complies with the global goals and objectives, as defined by our global

commitment to the UNGC, and our pledge and actions to each of the 10 principles have strong roots in our global policies and statements.

Reduction in relative CO₂ emissions in a period of growth

Globally, KPMG pledged to further reduce net emissions per FTE by 10% against a baseline year of 2016 and aim to purchase 100 percent renewable energy for our offices by 2020. Our commitment to KPMG's global ambition to reduce our net greenhouse gas emissions has seen a steady reduction in our carbon emissions per FTE in Denmark over the last three years.

KPMG in Denmark reduced relative carbon emissions (CO₂ per FTE) by 7% between 2017 and 2018, to 2,01 tonnes of CO₂ per FTE. Compared to the baseline year of 2016, we have reduced relative carbon emissions by 11%.

The scope covers scope one and scope two emissions from: electricity use from our Copenhagen headquarters, as well as our offices in Aarhus, Aalborg and Kolding, air travel booked for business purposes, and car travel mileage registered. KPMG employs standard energy saving initiatives such as primarily using LED light bulbs that automatically turn off after 30 minutes of inactivity. In 2018, a new and more energy-efficient ventilation system was installed at our headquarters in Copenhagen.

Reducing the environmental impact of our facilities

We collaborate with Meyers corporate catering, a company that uses 40% organic fresh produce for lunches five days a week. The waste in our offices is sorted according to their type, including paper, ink cartridges and used coffee grounds.

Honest talks at Folkemødet, the People's Political Festival 2018

Folkemødet, also known as The People's Political Festival, provides a good opportunity once a year to have an honest and direct dialogue with politicians, NGOs, business leaders and Danes in general discussing how we all can make a positive difference in our communities irrespective of background.

In FY18, KPMG hosted a well-visited panel debate at Folkemødet focusing on how we can ensure that disruptive technologies like AI can benefit all of us. Our CEO, Thomas Hofman-Bang, took the discussion with Bjarne Corydon, former finance minister and current chief editor at the Danish business media Børsen, together with the CTO of the online supermarket business Nemlig.com Anne-Sofie Nielsen and associate professor Natalie Schlüter, Head of Data science at the IT University of Copenhagen. We are looking forward to returning in 2019.



Inclusion and Diversity

To work at KPMG is to see the world differently, through many different perspectives and with a truly collaborative spirit. We empower our people to be themselves and respect others – it is core to our values and what we believe in. Our commitment to being inclusive and diverse is a celebration of difference and a moral imperative.

By fostering a welcoming environment for all people, we can leverage our inclusion and diversity to deliver exceptional client services. We are therefore proud to count more than 26 different nationalities working at KPMG in Denmark, reflecting a truly international and diverse workplace. Regardless of nationality, sexual orientation, and socio-economic background, we provide equal opportunities to both genders in recruitment and promotion processes, which was strongly recognised by our employees in our annual people survey.

Increased promotions of women

In FY18, we were delighted to have increased the promotions of women by 10%. Overall, 35% of all promotions were women, which reflect our commitment to provide equal opportunities in KPMG. Today, 38% of all our employees including partners are women, and we are proud to have supported women in their efforts to attain higher positions and that women represent 40% on our Board of Directors. Our Board consists of five highly skilled partners, of whom two are women, including the Chairman of the Board.

We strive to continuously improve our diversity targets in Management and target a gender balance ranging between 40-60% in Management levels below the Board of Directors (i.e. Leadership Team and other leaders reporting directly to the CEO). Today, our top management level consists of eight people, of whom five are

men and three are women, corresponding to a total of 38% women. We are proud to have balanced gender representation on our Board and in top management. At the same time, we continue to strive for further advancement across all management and staff levels.

Improving gender equality

Part of our plan to improve gender equality starts with our annual graduate and trainee intake. Last year, the intake matched our current gender split at KPMG, and we had ambitions to improve further in FY18. However, we have not been able to achieve this goal yet. We onboarded the same absolute number of women, but the growth stems from increased male intake. We are not satisfied with this development, but are affected by, among other factors, the gender imbalance at the STEM educations.

Global inclusion and diversity framework

Our new Global Inclusion and Diversity strategic framework focuses on initiatives like inclusive leadership and unconscious bias training, global networks and building robust measurements and metrics. We offer maternity and paternity coaching programmes, trainings and talent acquisition strategies every year to our employees in order to provide meaningful support to all our staff.

As part of our values, we respect the individual and therefore do not tolerate harassment and discrimination. This is clearly reflected in our actions and communication to our employees.

Our global Code of Conduct sets forth our complete value set, as well as our collective commitments, including business ethics. It can be downloaded online at www.kpmg.com.



KPMG Services in Denmark

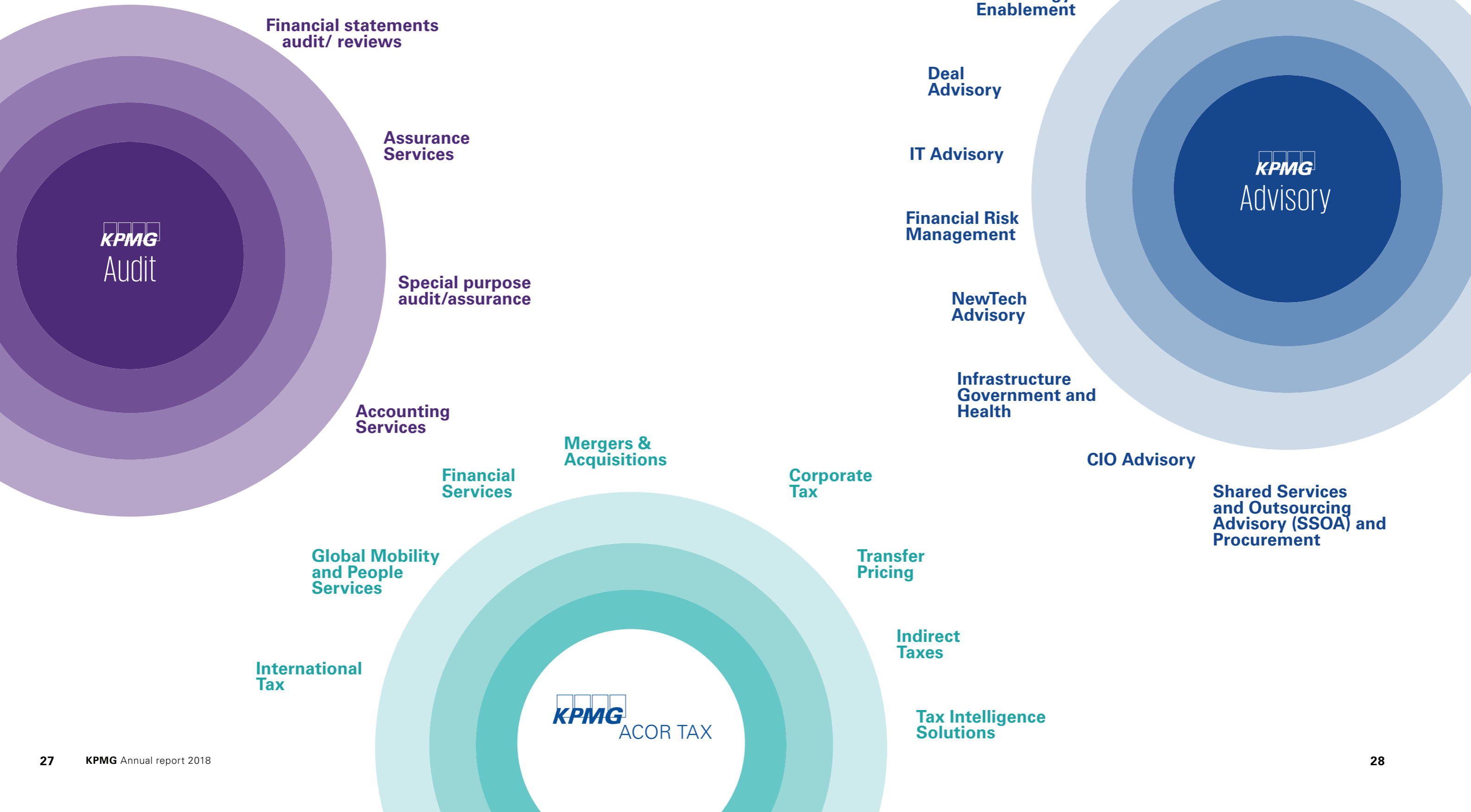



Using data to secure confidence and trust in a digital age

In today's society, we are all challenged with regulatory complexity, evolving business models, and people's changing needs. But above all, it is the rapid technological development which is the biggest game changer that we all need to address, no matter what kind of business we are operating in.

Technological solutions based on artificial intelligence combining data and analytics from internal and external sources are very powerful tools for any modern organisation and naturally form the basis for more and more decisions. However, one of the key challenges when using such technologies is the data they rely on, as unreliable data may drive businesses to make incorrect decisions.

We recognise that in the near future, we as auditors will not only focus on auditing financial statements but on providing assurance on data and information on a continuous basis, which can be used for more effective and accurate decision-making by stakeholders. Our purpose is therefore to provide confidence and trust in information and data used by businesses, shareholders and other stakeholders and by this empowering change that will benefit society as a whole.

Expanding our service offerings

To ensure we meet our clients' expectations for a modern day audit offering, we expanded our service offerings in FY18 by focusing more on assurance of data and information. FY18 was a strong year for our audit business, which grew 6.2% across large clients, mid-market and smaller clients. In the large clients segment, we won the audit of Royal Unibrew, LM Wind Power and Total E&P Danmark as well as Dansk Undergrund Consortium (Danish Underground Consortium).

Since the regulatory environment is constantly changing, we are also deeply engaged in helping clients with the challenges occurring from these changes. We continued to build on our growth from previous years by hiring more people and servicing more and more businesses often in close collaboration with colleagues from other business areas to provide the most value. We serve a wide range of businesses ranging from start-ups to large listed companies, and we are ready to bring value to more companies that will be subject to audit rotation in the coming years.

“ KPMG as an auditor of Unity has operated in a professional, agile, accurate and collaborative manner across our European operations, ensuring compliance and providing additional support and flexibility when needed. This approach has been extremely valuable to us and is key to supporting the global growth journey that Unity Technologies is on.

Jon Orpen,
Finance Director EMEA, Unity Technologies

Beyond traditional accounting in the mid-market segment

Through a number of exciting wins in FY18, we have increased our value proposition to the mid-market segments, resulting in a solid mid-market presence. We grew our base of national mid-market clients by approximately 25% over the last year.

“ We use KPMG for high quality auditing and strategic sparring. KPMG brings valuable insights on many aspects of our business.

Michael Søgaard Rasmussen,
CEO, Spangenberg & Madsen

Our main focus is on innovative start-up companies, fast-growing companies and family-owned businesses. For example, we audited the innovative growth company Unity Technologies across its European operations. Unity is the creator of the world's most widely used real-time 3D development platform, giving developers around the world the tools to create rich, interactive 2D, 3D, VR and AR experiences. As a result, we expanded our business relations with a number of fast-growing companies during the year and proved our relevance within this segment.

Embracing the entrepreneurial culture

We embrace the entrepreneurial culture and mindset in KPMG, and it is therefore a natural step for us to be actively involved in the start-up environment and go beyond traditional accounting to help our clients. During the year, we supported Danish Tech Challenge arranged by The Danish Industry Foundation (Industriens Fond), Greentech Challenge, a competition for start-ups with environmental ambitions backed by the Confederation of Danish Industries (DI), and TechBBQ, Denmark's largest tech and innovation summit bringing over 16,000 tech-interested people to Copenhagen in 2018.

“ KPMG has made a seamless transition into the role as new auditor for Royal Unibrew and demonstrated strong and experienced team capabilities.

Lars Jensen,
CFO, Royal Unibrew

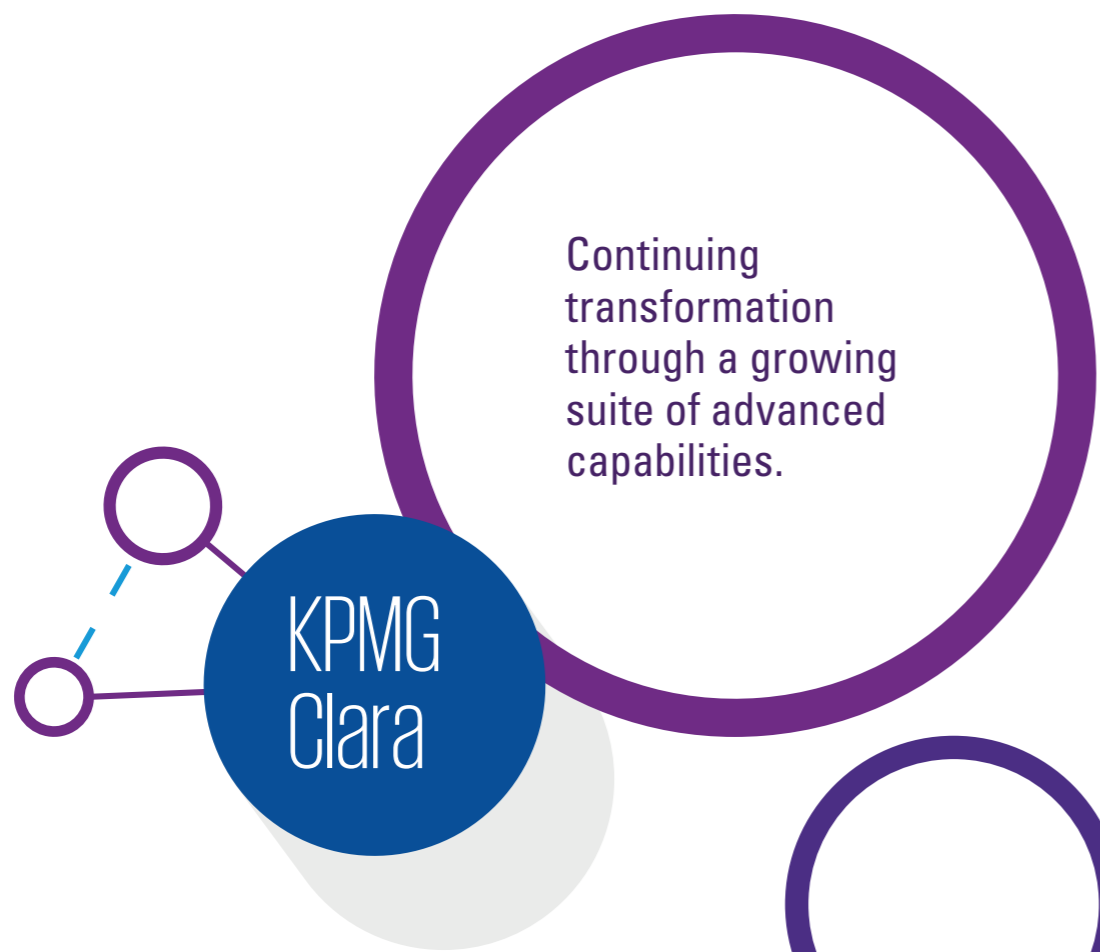

Continuing transformation through a growing suite of advanced capabilities.

KPMG Clara

Unlock the power of innovation

Driving quality through innovation – KPMG Clara

Audit quality is KPMG's number one priority; it is at the heart of everything we do, and we are compelled to constantly enhance the quality and relevance of audit. This is why we use artificial intelligence and other disruptive data and analytics tools to drive innovation at every level in KPMG.

KPMG Clara leverages the data we already examine as part of the audit and turns it into insights for the benefit of businesses and key stakeholders. The insights we provide through KPMG Clara give organisations a different perspective — whether through benchmarking and peer comparison, use of external and unstructured data or insights from KPMG's recognised industry expertise.

KPMG Clara helps businesses take stock of their financial position, learn about their performance, understand where they could be doing better, and prepare for what the future may bring.

Consequently, our clients will receive greater and more actionable insights from our audits. KPMG Clara is the beginning of a new era for audit — a gateway into the digital future.



on higher risk



KPMG Clara



Focus on data

KPMG Clara puts Data & Analytics at the heart of the audit approach.



Extensive evidence

KPMG Clara enables us to analyse 100% of a data population, providing more extensive audit evidence.



Advanced insights

KPMG Clara gives enhanced business insights enabling teams to pose more meaningful questions to our customers.



Focus on the risk areas

KPMG Clara makes use of intelligent automation and non-biased algorithms that let our people focus on the higher risk areas of the audit.

Assurance instills confidence

When organisations think about audit and assurance, they often exclusively focus on assurance of the financial statements. However, assurance can be applied to all of the information that is used to manage, govern, transact with and invest in an organisation as well as managing risks in disputes and assessing contract compliance, etc.

So when the market demands more accountability and transparency from companies in all aspects of their business, assurance instills confidence in the important decisions that management makes on behalf of an organisation and its advisors. The discipline covers everything from non-financial information such as CSR and sustainability reporting as well as other financial information such as special purpose financial reporting prepared to support claims and disputes and investigations.

In 2018, KPMG provided valuable inputs to disputes and legal cases supporting clients, lawyers and courts to make credible and assured information available for decision-making. In addition, we facilitated independent investigations and assessments for private companies, public authorities, and agencies. We performed internal audits as well as provided assurance over compliance with regulations, including the GDPR regulation which came into effect in May 2018. KPMG also supports internal audits and acts as an Independent Accounting Expert in restructuring processes and providing assistance for bankruptcy estates.

“ KPMG has gone beyond traditional accounting and administrative services. This has made it easier for us to think strategically about our financial planning and growth strategy. A partner like this enables small companies like us who are navigating a growth path to handle our financial management much better.

Vinay Venkatraman,
CEO, Leapcraft ApS

Acceleration in the adoption of sustainability

Throughout 2018, we saw an acceleration in the adoption of sustainability as a business priority across industry sectors. While this is partly due to sharpened compliance regulations, this shift is increasingly motivated by an understanding that sustainability and social responsibility issues not only affect reputation, but also the financial bottom line. These factors are further influenced by an increased focus on Environmental, Social and Governance (ESG) by the financial sector and the UN Sustainable Development Goals (SDGs).

In today's rapidly changing world, it is essential to build long-term value. We see a need for guidance across industry sectors through not only compliance, but also strategic sustainability advisory and assurance services. To date, we have worked with companies in industries ranging from asset management to industrial manufacturing to explore opportunities and solve complex sustainability challenges. These services come out of our growing CSR & Sustainability Services team, and include sustainability strategy development, materiality, sustainable supply chain, ESG risk and due diligence, Task Force on Climate-related Financial Disclosures (TCFD) recommendations, impact assessments using KPMG's True Value methodology, reporting and assurance.

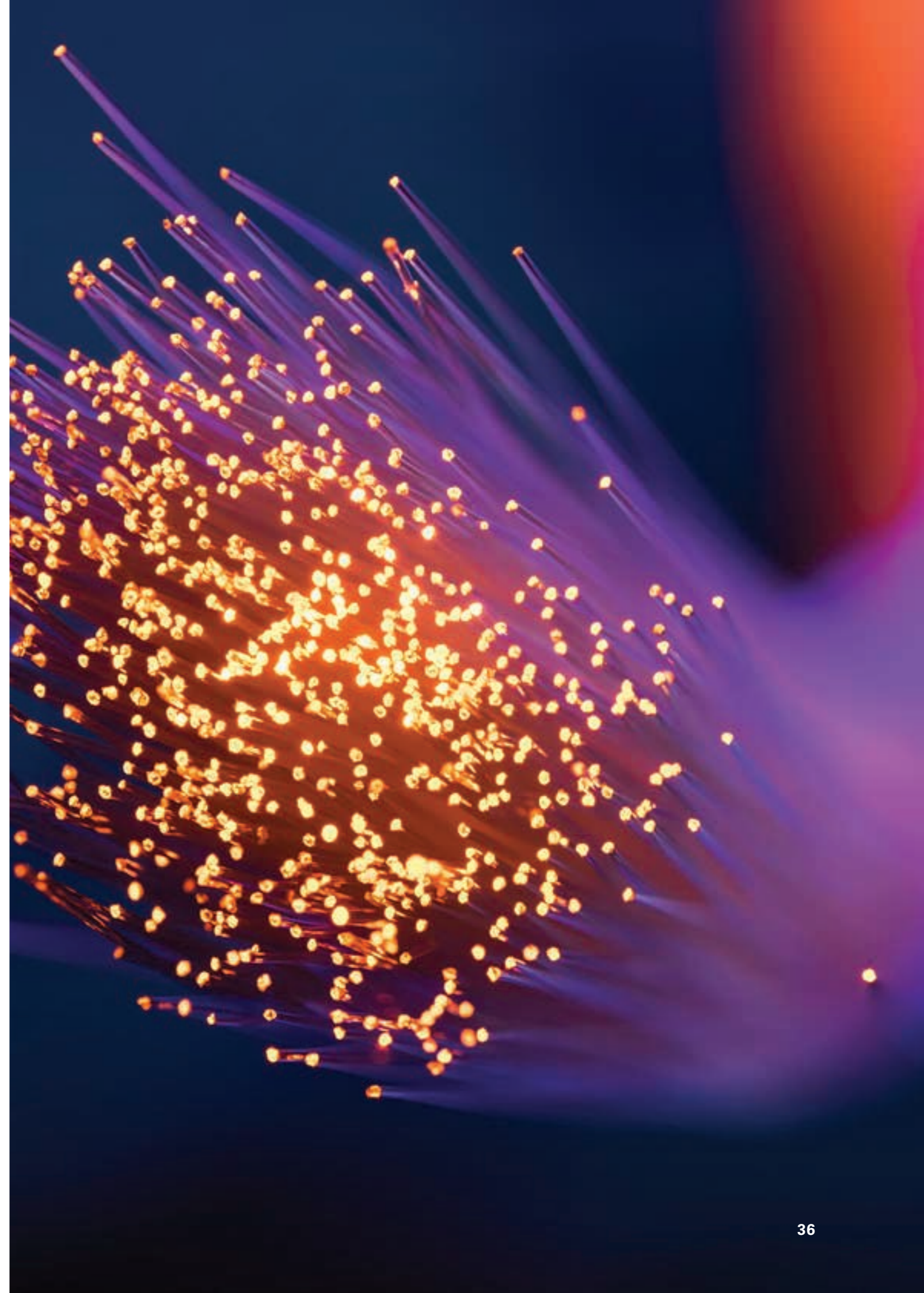

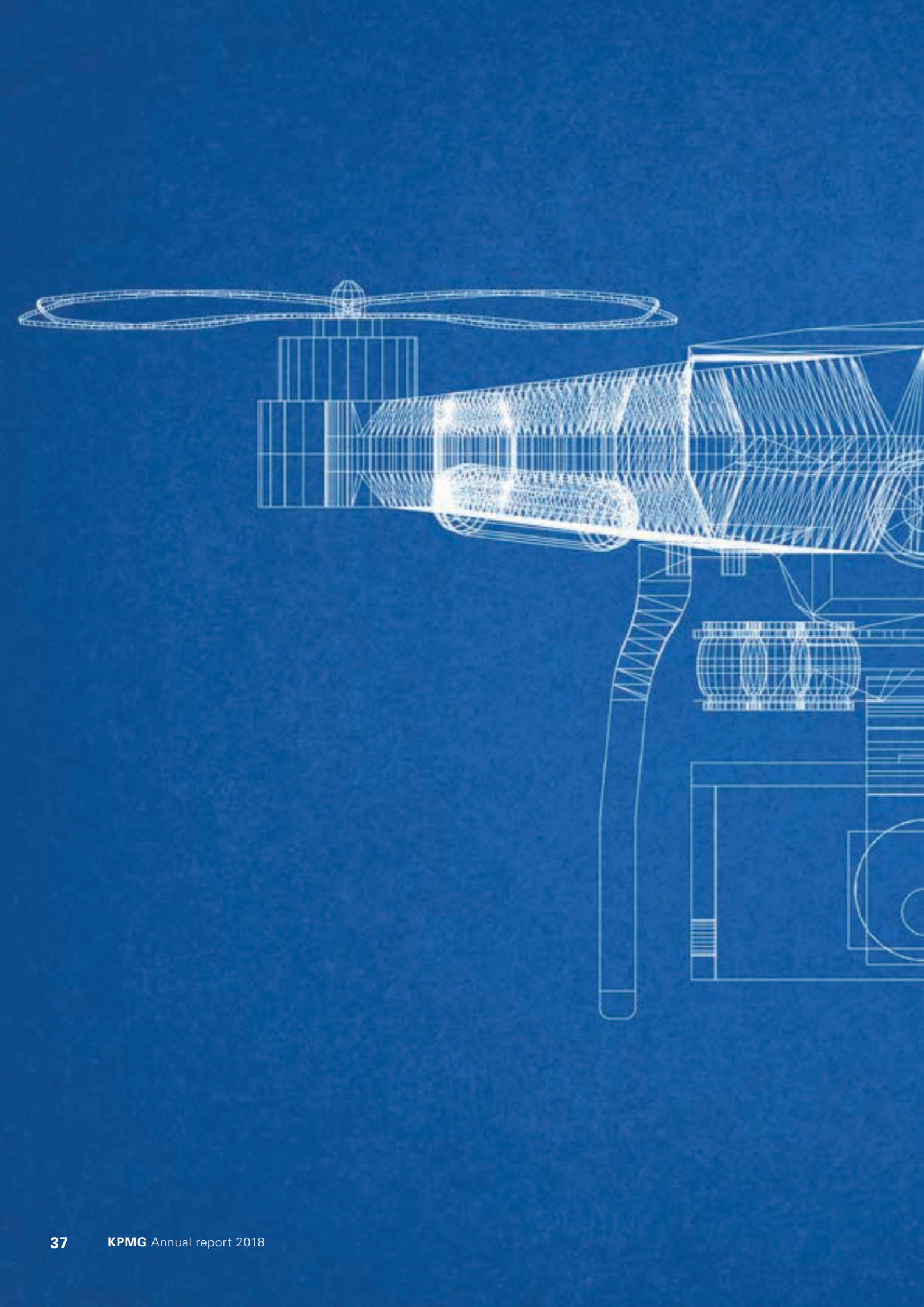

Building a future-fit business

KPMG has in-depth industry knowledge across a wide range of sectors and the financial services industry is a major priority. Business is no longer business as usual for the finance services industry, and there is no escaping the fact that the industry will change significantly in the coming years. Regulations are tightening and there are volatile macroeconomic conditions at play. Advancement in new technologies like robotics, machine learning, artificial intelligence and advanced analytics among others, will dramatically impact the finance sector. In addition, the sector is facing changing demographics with new preferences and consumer patterns as well as new entrants from other industries and Fintechs.

In these conditions, our clients are under relentless pressure to manage compliance and costs. On top of that, players in the market need to know how to innovate at scale to provide the best service to their customers and to build efficient and future-fit businesses in compliance with regulation in order to be trusted by customers and society. Their ultimate question is how to grow profitability amidst all these

headwinds. In short, at KPMG we help our clients in the sector to navigate these changing environments and transform challenges into business opportunities.

KPMG has several large insurance companies and banks as clients in both Denmark and the Nordic region such as Codan, Trygg-Hansa, If, Skandia, Jyske Bank and Nordea. In FY18, we assisted some of these and other clients with different challenges such as implementing the new accounting standards IFRS 9 and IFRS 17, performed financial due diligences and advised on regulation on capital requirements for banks and insurance companies. In addition, advising on anti-money-laundering and sanctions, providing assistance in connection with the change of core IT systems and preparing for Brexit was also part of our portfolio with customers in the financial sector this year.

These projects provide great examples of how we work closely with our clients and utilise our skilled workforce of people both locally and globally who have extensive knowledge of the industry and its transformation drivers.

“ Audit quality and building trust are at the core of our foundation at KPMG. Our commitment to quality and trust is reflected through our people and processes, while utilising innovative technologies to deliver high-quality audits and insights.

Lau Bent Baun,
Head of Audit

Entering the era of New Practice

Transformation is critical

In order to stay ahead in the global technology race, leaders need to prepare their organisations for an era with radical digital transformations. As organisations start scaling their use of new technologies, the obvious use cases and best practices eventually run out. Outside the realm of the obvious, use cases are the high-value cases which innovate business models and generate better experiences for both businesses and its customers. To identify these and to design the solutions which can realise these benefits, KPMG has introduced the New Practice framework.

“ Working with clients on their digital transformation journey goes beyond technology and implementation; it is equally important to build a digital culture to drive change that delivers true value.

Morten Mønster,
Head of Advisory

The New Practice framework discards the notion that automation technologies are made solely to automate human work. Instead we focus on how to empower people to deliver more value-creating work, whilst re-engineering processes to boost artificial intelligence capabilities across the entire organisation. We hereby challenge and enable organisations to make business leaps instead of using disruptive technologies to drive incremental change.

Implementing advanced automation technologies

Simple automation is being commoditised and becoming available to more types of organisations. We see that this has enabled larger organisations to become more advanced in the solutions they create. More advanced automation technologies such as conversational artificial intelligence and customised machine learning algorithms are being developed to help solve highly complex problems. This also means that more automation technologies are being combined to automate complex end-to-end processes which include both transactional steps, conversations and intelligent decision-making. More and more companies are looking to build an artificial intelligence strategy and a roadmap detailing how to deploy artificial intelligence.

“ KPMG helped us accelerate our digital efforts throughout the business and they are our preferred automation partner. Each time they have delivered solid collaboration and results.

Jens Liisborg,
Department Director, Business Optimization, Nykredit

In many of our engagements, we drive business value and profit both through improving revenues as well as reducing costs, showcasing the value that artificial intelligence may have for our clients. We also help our clients to automate many of their time-consuming and repetitive tasks, which frees up time for their employees to focus on more value-generating activities. An example is

our collaboration with TDC, where we helped them upskill their local RPA team, implement a scalable robotic process automation operating model and automated several processes. TDC has since then subscribed to our automation as a service offering to boost the development capacity to meet their ambition, leveraging our near-shore team to provide quick results.

Raising the bar with new technology

KPMG is focused on constantly pushing the boundaries of what is possible with new technologies. But more importantly, as the rapid pace of technology gives rise to distrust of science and technology, we strive to ensure that technologies are used for the good. This not only means that we want to prioritise the use of technologies to solve problems in our society, but also that we want to create the frameworks so that all technologies that are being developed inside and outside of our organisation are of the right quality and made with the right intentions.

KPMG expects to enter into new advisory and technology delivery areas which are currently not being offered by any other of the Big Four companies globally today.

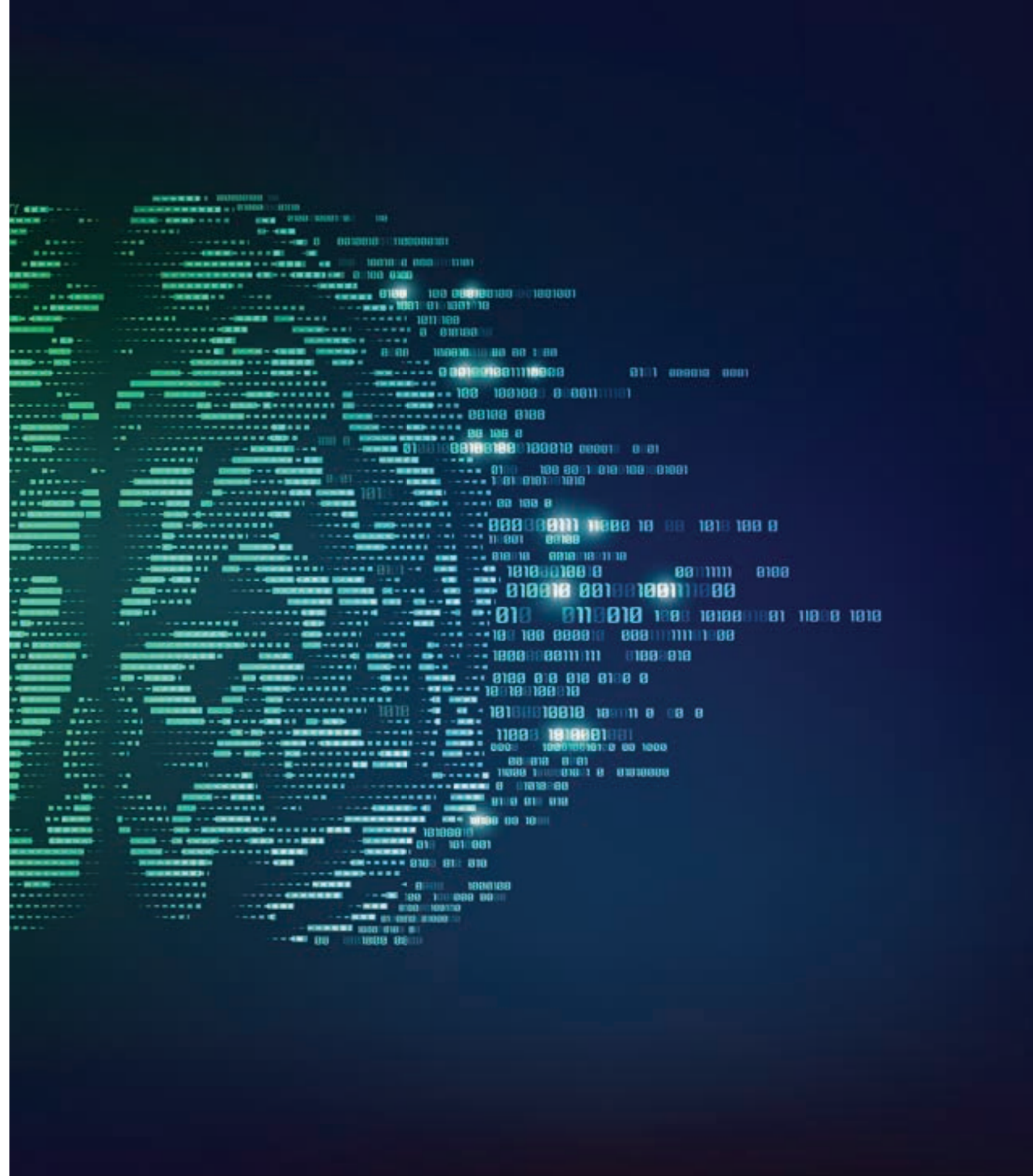

“ KPMG has established a near-shore setup of robobuilders for TDC Business delivering competitive and qualified automation-development based on our needs. The setup is governed by KPMG's highly skilled automation architects bridging our in-house consultants with near-shore developers. Combined with excellent project management, KPMG has overall delivered with high quality on a very complex solution designed by us.

Peter Marcker,
Head of Automation, TDC Business

“ KPMG has played a key part in accelerating our journey towards becoming more data-driven. In Egmont, being data-driven is integral to our strategy of growing with the modern consumer across our media businesses that include leading positions within television, e-commerce, cinemas and games.

To be data-driven is about using data to connect with the individual consumer to offer better customer experiences through engaging products. KPMG has delivered on their second-to-none offerings within machine learning and statistics excellence in measuring market feedback, which forms a sound basis for driving change in our organisations. Thanks to their pragmatic results-driven approach, KPMG has delivered, which made them the clear choice for us.

Frederik Fabritius,
Head of Advanced Analytics, Egmont

Building the public sector of tomorrow

The public sector is already facing disruption and will undergo immense transformations in the coming years. Our multi-disciplinary teams in KPMG assist clients on this journey, taking their starting point in strong sector expertise coupled with in-depth knowledge of technology, operational efficiency, transformation and management.

During the past year, we have worked for a large number of different clients at central, regional and local government level. Our clients include Danmarks Nationalbank, Finansministeriet, Sundhedsministeriet, Forsvaret, Banedanmark, Vejdirektoratet, Ankestyrelsen, Region Hovedstaden and Københavns Kommune.

To us, working with the public sector means working with a clear purpose and a strong commitment. Our clients are each in their own way making a positive difference in society, ranging from the area of energy, transport, infrastructure and healthcare, to central and local government. We recognise our societal responsibility in helping our clients implement transformational strategies efficiently and effectively and with high quality for the benefit of our clients and ultimately the Danish citizens.

Transforming infrastructure services with data-driven solutions

In 2018, KPMG supported Sund & Bælt Holding A/S, one of the biggest infrastructure players in Denmark, on their journey to becoming a digital front runner. Sund & Bælt is currently undergoing a strategic transformation towards becoming a data-driven organisation by taking advantage of digital opportunities such as drones, 3D visualisation and artificial intelligence technologies to strengthen their growth and productivity. As a strategic partner, IGH helped Sund & Bælt develop a cutting-edge

data-driven decision-making tool, which increases transparency and reduces capital reinvestments and operational costs in the entire value chain. In addition, we supported the organisation in structuring their vast amount of asset data more efficiently, generating more value for fewer resources. We experience a strong demand among organisations wanting to become more data-driven.

“ KPMG has proven to be a high-performing and very dedicated partner bringing valuable technology insights and a dedicated team.

Mikkel Hemmingsen,
CEO, Sund & Bælt Holding AS

Seizing the potentials of digitalisation

The Danish Business Authority (Erhvervsstyrelsen) is currently working on an initiative under the "Digital Strategy 2016-2020" to enable automated business reporting of financial data. The objective of the initiative is to reduce the administrative burden for businesses and create better and more timely financial data for public authorities and other stakeholders. KPMG collaborated with and supported the Danish Business Authority by conducting a number of analyses using our deep sector expertise combined with strong analytical capabilities and an in-depth digital know-how.





“ In Erhvervsstyrelsen, we strive to make it easy and attractive to run a business in Denmark. Our efforts to enable automated business reporting for businesses is an integral part of these endeavours. KPMG has been a valued partner on this project, accompanying us in our journey towards seizing the potentials of digitalisation and creating the best possible framework for businesses across the country.

Carsten Ingerslev,
Head of Department, Erhvervsstyrelsen
(The Danish Business Authority)

Shaping the future of customer experience

Customer experience is crucial and its importance is even stronger in a digital world. Nearly a decade of research and more than 2 million individual consumer evaluations have demonstrated that every outstanding customer relationship has a universal set of qualities – what we call The Six Pillars of Customer Experience Excellence. Each year, we release the report "Customer Experience Excellence" highlighting the brands and sectors with performing best on customer experience. The brands that understand and deliver against The Six Pillars have proven to deliver enhanced outcomes, achieve faster growth and create greater shareholder value.

The Six Pillars of Customer Experience Excellence:

1



Personalisation

Using individualised attention to drive an emotional connection.

2



Integrity

Being trustworthy and engendering trust.

3



Expectations

Managing, meeting and exceeding customer expectations.

4



Time and Effort

Minimising customer effort and creating frictionless processes.

5



Resolution

Turning a poor experience into a great one.

6



Empathy

Achieving an understanding of the customer's circumstances to drive deep rapport.

Empowering business through technology

Many organisations are faced with legacy systems and outdated operating models, which is a serious challenge in a competitive landscape shaped by data and technology. The market for enterprise software platforms has changed dramatically during the last five years, driven by an ever-increasing demand for solutions that are more flexible and rapidly deployable and that continuously deliver the most relevant business functionality. Furthermore, businesses are demanding a more rapid digital deployment model, driving a need for fundamental changes to traditional IT projects and organisational delivery models with a renewed focus on business relevance, growth enablement and speed to market.

In KPMG, we recognise these challenges but also the potential that lies in replacing legacy enterprise platforms and operating models with modern updated alternatives. By implementing cutting-edge software platforms, we help rationalise, simplify and automate businesses through Enterprise Resource Planning (ERP), Digital HR, Customer Relationship Management (CRM) and Business Intelligence & Analytics (BIA) from leading providers like Microsoft and SAP.

We drive further digital enablement of artificial intelligence, Internet of Things and other services through Cloud platforms like Microsoft Azure, Amazon Web Services and Google Cloud that have the potential to transform teams into agile, responsive and technology-savvy organisations.

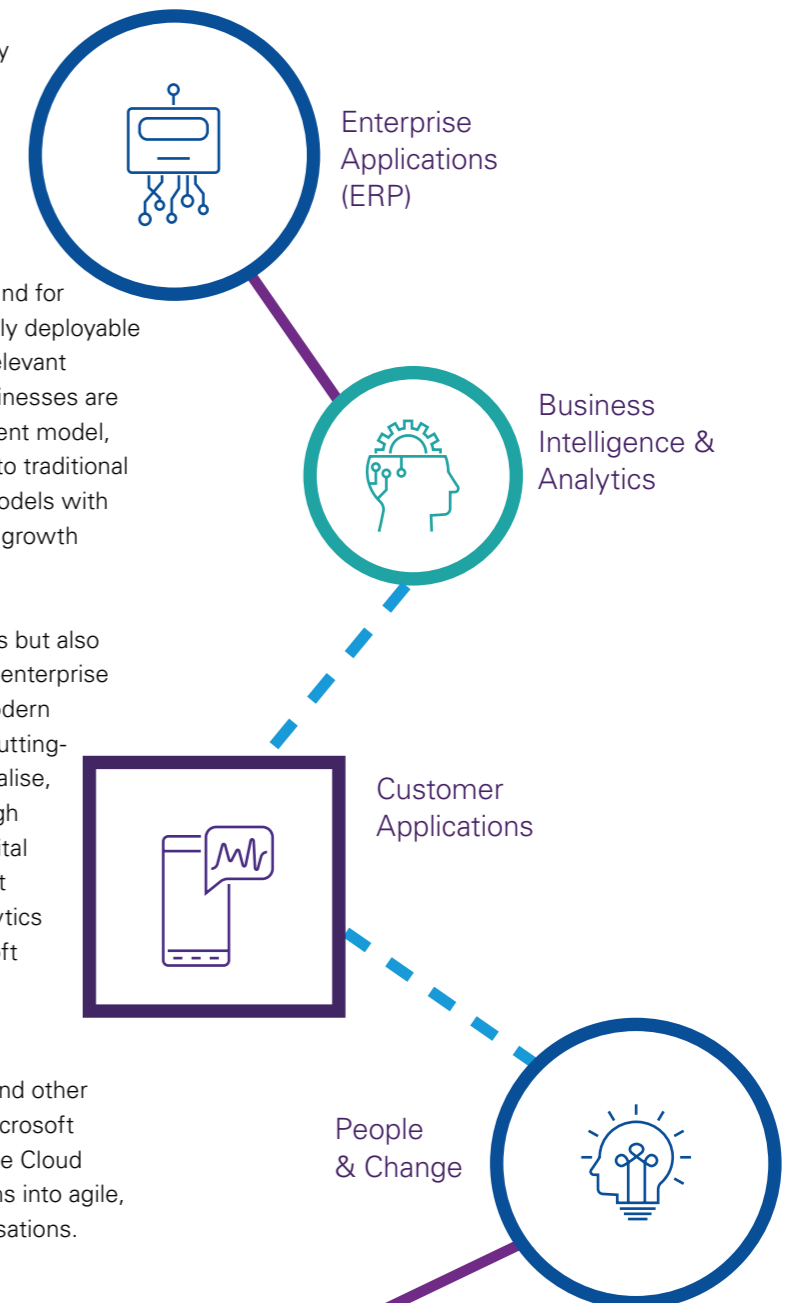

We profoundly believe in empowering businesses through technology, and a vital part of that is to ensure that organisations can keep pace with the rapid development of digital solutions and utilise these effectively and consistently.

New data models and shared platforms

This year, for example, we helped Food Folk Group – the company behind McDonald's in Denmark - to replace three legacy ERP systems with one modern shared platform as part of a group consolidation of four markets in the Nordics. KPMG also assisted a global pharma company with headquarters in Denmark in designing and implementing a new Business Finance data model based on SAP BW HANA technology, as well as enhancements to its existing planning and consolidation IT solution based on SAP BPC. Ultimately, KPMG helped the company

improve data integrity and increase the value delivered from the reporting solutions.

KPMG also helps companies streamline their processes for management of master data and improve the quality of the master data across global organisations. In FY18, we helped industry-leading hearing aid company Widex design new efficient processes. Widex is one of the most innovative companies in the hearing aid industry. In April 2018, Widex launched its new strategy aimed at doubling the company's size in five years and becoming a leading innovative company with second-to-none new product launches. To realise the strategy, Widex needed to streamline its processes for management of master data across a global organisation and improve the quality of its master data.

KPMG helped Widex design new efficient processes for master data management and a new governance

structure with clear roles and responsibilities for master data across the global Widex organisation. Furthermore, KPMG helped Widex define business rules for maintenance of master data to improve quality and ensure global standardisation of critical master data. KPMG worked in close collaboration with Widex using KPMG's proven methodology for master data management. In addition to the improvements in the quality of master data, the new way of working helped Widex become more process oriented and integrated across the functions in the company.

Global network and capabilities

KPMG works efficiently across regions with other KPMG member firms. For example, we successfully delivered advisory services globally to empower customer excellence and digitalise the full agenda of Customer Relationship Management for the Rockwool Group in FY18. This is an example of working successfully shoulder to shoulder with our client across regions from strategy and process alignment through to delivery, technical implementation, support and adoption in the business.

Establishing a regional hub in Singapore

Being part of a large-scale SAP roll-out implementation in FY18 for a Danish client, KPMG successfully established a regional KPMG hub in Singapore with strong local capabilities and subject matter expertise in order to provide efficient and trusted support to the SAP roll-out organisations in Japan, China, Korea and Singapore.

To ensure successful adoption, we embed targeted behavioural change management into our projects, which reduces risk, drives organisational adoption and increases return on investment.

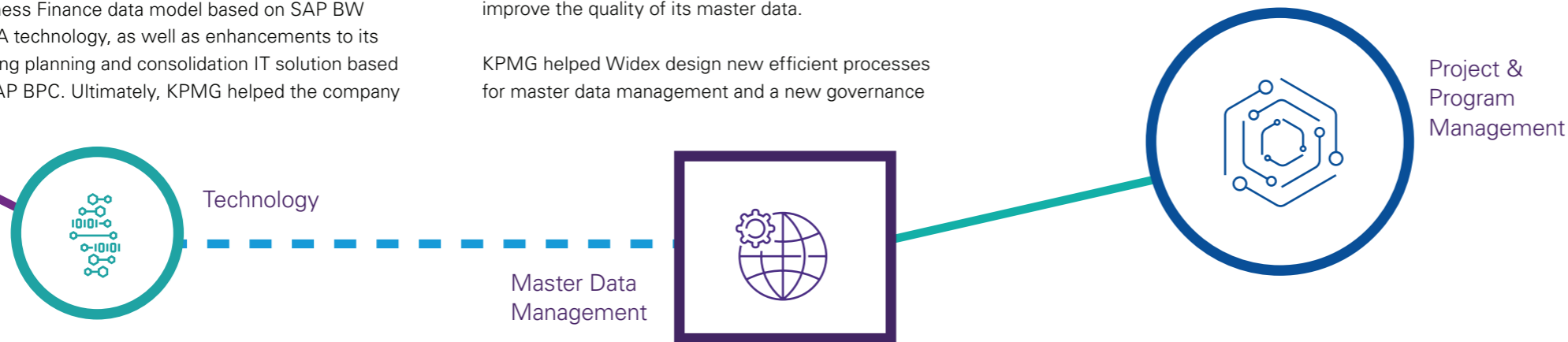

“ During KPMG's time with Food Folk Group, KPMG's consultants have always brought the perfect spirit to work by being positive, energetic and demonstrating a "can-do attitude" even when situations were challenging.

Eric Jansson,
Head of Finance Norway and Head of ERP Group Deployment, Food Folk Group



Driving digital value for CFOs

It is evident that the current technological advancement will lead to extreme automation that will challenge the status quo and dramatically change the size, structure, and delivery model of the finance function. The future finance function will imply a much simpler and more streamlined organisation with significant changes to what, how, where and who will perform the work. The CFO and the finance function are uniquely positioned as value creators since they span the entire value chain, house analytical competencies and already act as a business partner to the business leadership.

New skills and capabilities required

Increased accessibility to both internal and external data will pave the way for algorithms and advanced analytics that will provide new data-driven insights and change the way the finance function plans, forecasts and reports. However, to fully leverage the potential of new technologies, new skills and capabilities will be required in future finance functions. It is not enough to be a world-class finance professional and have a good business understanding. Data modelling, analytics and insights competencies are prerequisites in future finance functions to take advantage of the digital opportunities and convert them into business value.

A wide range of strategic and digital projects

In FY18, KPMG assisted CFOs with a wide range of strategic and digital projects. We delivered complex economic modelling and analysis for large public infrastructure projects and helped large corporates with the design of budget processes, management reporting and internal controls frameworks. In these projects, we assisted our clients with changing the full operating model including governance, roles and

responsibilities, people, organisation and technology, which requires a strong change management capability from our team on the ground.

We successfully implemented robotic process automation (RPA) in finance and administrative functions to automate rule-based tasks, and we implemented intelligent automation, machine learning and algorithms to enhance data and process automation beyond simple robotic process automation.

We performed analyses linked to the automation of financial business reporting and assisted with advanced data-driven insight analysis. We expect these services to increase in FY19 in combination with the increased maturity in organisations in relation to utilising data to provide insights and create business value.

KPMG strives to work seamlessly across our service lines whenever it benefits our clients. In the case of CFOs, we always offer a multi-disciplinary team of experts who understand how to develop an extraordinary automation strategy and implement solutions for the needs of the modern CFO.

“ We have a strong focus on how digitalisation can be a lever in improving the quality and efficiency of our processes. KPMG helped us mobilise our resources and implement the first operational robotic process automation within a few weeks, which gave us a strong kick start on our automation roll-out across Alm. Brand.

Rasmus Werner Nielsen,
Group CFO, Alm. Brand



Advanced analytics in mergers and acquisitions

The current merger and acquisition environment is as challenging as ever, and due to increased competition, acquirers need to take an offensive stance when pursuing deals. Today's evolving data and analytics tools can provide dealmakers with the information they need to gain a competitive edge, and we find that these tools are of particular importance in the processes we are involved in. For instance, when used properly, these tools can transform the due diligence process and give acquirers much more control of the most important types of information.

We are grateful for the trust our clients show us, having assisted with both corporate finance and due diligence services on high-profile deals for leading corporate and private-equity clients and financial institutions over the past year. In 2018, we once again topped Mergermarket's due diligence provider list for the Danish market. Over the course of the year, we assisted, among others, with the acquisitions of Muuto, Dantaxi, Unifeeder, NGF Nature Energy and several of Royal Unibrew's acquisitions. From a sell-side perspective, we were fortunate to assist Forsikringens Datacenter and Ørsted as well as on NKT's divestment of their catenary business.

Working shoulder to shoulder with our colleagues in M&A Tax and with KPMG member firms around the globe, our cross-border, cross-functional Deal Advisory team offers highly skilled and specialised market-leading advisory services within all finance and tax aspects of mergers and acquisitions. As in past years, we once again assisted a significant number of clients and were involved daily in mergers and acquisitions of businesses of all sizes.

Examples of tools we apply for the benefit of our clients:



Advanced Analytics

Gaining valuable insights from unstructured data online and from internal sources to drive informed, open and honest discussions around valuation, pricing negotiations, planning and more.



Strategic Profitability Insights

Providing deep analytics on how a business generates sales and profits to enable you as a buyer or seller to isolate a piece of business quickly and precisely and get a clear picture from numerous financial reporting angles.



Benchmarking Plus

Going beyond publicly sourced benchmark data to tap into our robust proprietary database of engagements across a range of industries.

Improving cyber security and compliance with GDPR

Due to the implementation of the new GDPR regulation and the rise of government-supported hacking, threats to Danish organisations, resulting from both non-compliance of the GDPR regulation and from offensive attacks, have grown exponentially compared to just a few years ago. Therefore, our clients turn to us for guidance on how to manage information security issues and to seek advice on tools and structures needed to support the governance.

Our engagement with BESTSELLER is a good example of how KPMG can support a client to strengthen security by using Identity Management to provide greater control of who has access to BESTSELLER resources. This both reduces risk of non-compliance to GDPR and provides processes that are more efficient for user and identity governance.

Change management services on GDPR

2018 saw the implementation of new GDPR and as a result, KPMG assisted a large number of organisations in preparing for the EU regulation. In addition, we conducted assessments of how GDPR ready an organisation is, developed policies for GDPR and implemented new processes and controls for ensuring compliance. However, for a number of organisations, it has proven difficult to build a lasting organisational anchoring. Therefore, we also created organisational change management services specifically for GDPR, assisting in setting up an organisation around continuous compliance.

Managing the inevitable cyber security breach

The Danish government has taken a number of steps to improve the national cyber security stance, including the creation of a national cyber security strategy and implementing the Network and Information Security Directive (NIS-directive). Subsequently, KPMG provided services to certain critical sectors and helped to implement a dedicated and sector-specific cyber security strategy.

No matter how well an organisation protects itself, security incidents will occur in any organisation. This is why incident management is a key part of a well-functioning cyber defence. As a consequence, we assisted a number of large public and private organisations in improving their cyber defence and business continuity plans, both by simulating attacks and by training in how to react when an incident occurs. This goes for both cyberattacks and when a privacy incident occurs that may not be related to an attack. In 2018, we helped to improve the cyber security for clients such as Danish Broadcast Corporation, Region Syd and PFA.

Finally, we assisted both software vendors and other clients with software license compliance and other contractual commitments. As complexity rises and hybrid-sourcing models prevail, we experience that compliance with contractual terms becomes increasingly difficult.





New technologies make tax transparent and responsible

KPMG services more than half of the top-listed companies in Denmark and the majority of the largest Danish and foreign-based multinationals with operations in Denmark. With a strong international network of experts, KPMG combines profound insight into Danish and Nordic affairs with global perspectives to pursue impactful business results for our clients.

Technology will significantly change the way we and our clients deal with tax, both in terms of compliance and advisory. Therefore, we have developed tax robots that utilises the newest technology in order for us to streamline and make our internal processes more efficient. This enables us to focus our time and human resources on projects where we can add value and make a real impact using our core

competencies. Together with our clients, we also utilise the best tax technology in order to set up indirect tax compliance in ERP systems to gain significant insights by leveraging tax data analytics.

Digital and dynamic

Our Transfer Pricing and Tax Technology Team earlier this year developed and launched a dynamic and simple web-based transfer pricing tool (TPAD). TPAD optimises preparation of local transfer pricing files, ensuring a time-efficient process that minimises potential errors induced by manual handling of large data batches. The advantages of TPAD are many, and the tool has already been well-received in the Danish market and is now being rolled out to the rest of the KPMG network globally.

Utilising technology and a strong global delivery model

In today's complex regulatory environment, it is increasingly important that multinational groups can show that they have good governance, strong controls and effective compliance with local regulations. Our Global Compliance Management Services (GCMS) practice supports multinational groups in transforming the management of their worldwide tax compliance through outsourcing and consulting services. The GCMS practice covers direct and indirect tax reporting, tax accounting and statutory financial statements preparation and reporting for the client's entities.

After a very successful last year in this area, we secured new major wins as an outsourcing partner for several global tax compliance and reporting services for Danish-headquartered multinationals. On top of delivering Danish tax compliance, our GCMS team now coordinates compliance and reporting obligations in more than 70 countries while maintaining a central overview of global compliance levels.

As a result of large investments on a global scale, KPMG offers leading compliance technology, processes and advice in the market. Our clients' increasing focus on the outsourcing of tax compliance and reporting is expected to further contribute to our growth.

The increased importance of tax controversy and compliance

Tax dispute resolution is still an area for which we are foreseeing further growth due to complexity in legislation and the continued rise of cross-border transactions. KPMG is recognised in the market as the leading tax dispute resolution and controversy firm in Denmark. Whether it is SKAT or a foreign tax authority that raises a claim against one of our clients, our tax dispute resolution and controversy leaders assist our clients to protect against, prepare for, and resolve disputes with tax authorities.

OECD's Base Erosion and Profit Shifting initiative has set a new global agenda for closer regulation of multinational companies. Following the tax authorities' implementation of the new rules in Denmark and abroad, C-level executives recognise the importance of tax controversy and compliance more than ever before. To meet the need in the market, KPMG has launched a tax dispute resolution and controversy network that brings together tax dispute resolution and controversy specialists from all over the world to share best practices.



Preferred provider within the automotive industry

KPMG continues to be a preferred provider of services for the automotive industry. In FY18, KPMG developed an online tool for calculating vehicle registration tax which has revolutionised the way those calculations have been done historically, minimising calculation errors and automating manual processes. The automotive industry has responded very positively to the new tool, which is being used in the main supply chain from importers, financial and leasing providers and larger dealers.

Our Global Mobility practice helps companies manage the demands of growing a global workforce. As robotics takes hold of business, creating both qualitative and quantitative advantages, it is increasingly important that we change the way we think of technology and the way we function in a changing global landscape.



Our KPMG Values

Our values create a sense of shared identity. They define what we stand for and how we do things. Our values help us work together in the most effective and fulfilling way and bring us closer as an organisation.



We lead by example.



We work together.



We respect the individual.



We seek the facts and provide insight.



We are open and honest.



We improve communities.



Above all, we act with integrity.



Statement by the Board of Directors and the Executive Board

The Board of Directors and the Executive Board have today discussed and approved the annual report of KPMG P/S for the financial year 1 October 2017 – 30 September 2018.

The annual report has been prepared in accordance with the Danish Financial Statements Act.

It is our opinion that the financial statements give a true and fair view of the Company's assets, liabilities and financial position at 30 September 2018 and of the results of the Company's operations and cash flow for the financial year 1 October 2017 – 30 September 2018.

In our opinion, the Management's review gives a fair review of the development in the Company's operations and financial matters, of the results for the year and of the Company's financial position.

We recommend that the annual report be approved at the annual general meeting.

Copenhagen, 18 December 2018

Executive Board:

Thomas Hofman-Bang
CEO and Senior Partner

Board of Directors:

Anette Harritz
Chairman and Partner

Anja Bjørnholt Lüthcke
Partner

David Olafsson
Partner

Bo Johansen
Partner

Danny Golan
Partner

Independent auditor's report

To the shareholders of KPMG P/S
Independent auditor's report
on the financial statements

Opinion

We have audited the financial statements of KPMG P/S for the financial year 1 October 2017 – 30 September 2018, which comprise income statement, balance sheet, statement of changes in equity, cash flow statements, notes including accounting policies. The financial statements are prepared in accordance with the Danish Financial Statements Act.

In our opinion, the financial statements give a true and fair view of the Company's assets, liabilities and financial position at 30 September 2018 and of the results of the Company's operations and cash flow for the financial year 1 October 2017 – 30 September 2018 in accordance with the Danish Financial Statements Act.

Basis for opinion

We conducted our audit in accordance with International Standards on Auditing (ISAs) and additional requirements applicable in Denmark. Our responsibilities under those standards and requirements are further described in the "Auditor's responsibilities for the audit of the financial statements" section of our report. We are independent of the Company in accordance with International Ethics Standard Board for accountants (IESBA Code) and the additional requirements applicable in Denmark, and we have fulfilled our other ethical responsibilities in accordance with these standards and requirements. We believe that the audit evidence we obtained is sufficient and appropriate to provide a basis for our conclusion.

Management's responsibilities for the financial statements

Management is responsible for the preparation of financial statements that give a true and fair view in accordance with the Danish Financial Statements Act and Management is also responsible for such internal control that Management determines is necessary to enable the preparation of financial statements that are free from material misstatement, whether due to fraud or errors. In preparing the financial statements, Management is responsible for assessing the Company's ability to continue as a going concern, disclosing, as relevant, matters related to going concern and using the going concern basis of accounting in preparing the financial statements, unless Management either intends to liquidate the Company or to cease operations, or has no realistic alternative but to do so.

Auditor's responsibilities for the audit of the financial statements

Our objectives are to obtain reasonable assurance as to whether the financial statements as a whole are free from material misstatement, whether due to fraud or error, and to issue an auditor's report that includes an opinion. Reasonable assurance is a high level of assurance but is not a guarantee that an audit conducted in accordance with ISAs and the additional requirements applicable in Denmark will always detect a material misstatement when it exists. Misstatements may arise from fraud or error and are considered material if, individually or in the aggregate, they could reasonably be expected to influence the economic decisions of financial statement users on the basis of the financial statements.

As part of an audit conducted in accordance with ISAs and the additional requirements applicable in Denmark, we exercise professional evaluations and maintain professional scepticism throughout the audit. We also:

— Identify and assess the risks of material misstatement of the financial statements, whether due to fraud or error, design and perform audit procedures responsive to those risks, and obtain audit evidence that is sufficient and appropriate to provide a basis for our opinion. The risk of not detecting a material misstatement resulting from fraud is higher than for one resulting from error, as fraud may involve collusion, forgery, intentional omissions, misrepresentations or the override of internal control.

— Obtain an understanding of internal control relevant to the audit in order to design audit procedures that are appropriate in the circumstances, but not for the purpose of expressing an opinion on the effectiveness of the Company's internal control.

— Evaluate the appropriateness of accounting policies used and the reasonableness of accounting estimates and related disclosures made by Management.

— Conclude on the appropriateness of Management's use of going concern basis of accounting in preparing the financial and, based on the audit evidence obtained, whether a material uncertainty exists related to events or conditions that may raise significant doubt about the Company's ability to continue as a going concern. If we conclude that a material uncertainty exists, we are required to draw attention in our auditor's report to the related disclosures in the financial statements or, if such disclosures are inadequate, to modify our opinion. Our conclusions are based on the audit evidence obtained up to the date of our auditor's report. However, future events or conditions may cause the Company to cease to continue as a going concern.

— Evaluate the overall presentation, structure and contents of the financial statements, including the disclosures, and whether the financial statements reflect the underlying transactions and events in a manner that gives a true and fair view.

We communicate with those charged with governance regarding, among other matters, the planned scope and timing of the audit and significant audit findings, including any significant deficiencies in the internal control that we identify during our audit.

Statement on Management's review

Management is responsible for the Management's review.

Our opinion on the financial statements does not cover Management's review, and we do not express any kind of assurance conclusion thereon. In connection with our audit of the financial statements, our responsibility is to read the Management's review and, in doing so, consider whether the Management's review is materially inconsistent with the financial statements or our knowledge obtained during the audit, or otherwise appears to be materially misstated. Furthermore, it is our responsibility to consider whether the Management's review provides the information required under the Danish Financial Statements Act.

Based on the work we have performed, we conclude that Management's review is in accordance with the financial statements and that it has been prepared in accordance with the requirements of the Danish Financial Statement Acts. We did not find any material misstatement of the Management's review.

Copenhagen, 18 December 2018

Redmark

Statsautoriseret Revisionspartnerselskab
CVR no. 29442789



Anders Schelde-Møllerup Funder
State Authorised Public Accountant

mne30220

Financial statements

KPMG P/S

1 October 2017 – 30 September 2018

Income statement

DKK'000	Note	2017/18	2016/17
Revenue	2	507,568	424,003
Other operating income		32,062	71,448
Other external expenses		-178,146	-161,617
Gross Profit		361,484	333,834
Staff costs	3	-356,598	-330,573
Depreciation, amortisation and impairment losses on software, equipment and leasehold improvements	5	-4,179	-4,254
Operating profit/loss		707	-993
Financial income	6	0	1,487
Financial expenses	7	-707	-494
Profit for the year	8	0	0

Balance sheet

DKK'000	Note	2017/18	2016/17
Assets			
Non-current assets			
Software	5	1,170	940
Equipment and leasehold improvements	5	7,695	5,254
Deposits	9	13,136	12,632
Total non-current assets		22,001	18,826
Current assets			
Receivables			
Trade receivables		109,095	111,793
Receivables from related companies		36	122
Services in progress	10	30,425	24,978
Other receivables		32,328	71,652
Prepayments	11	2,147	3,033
		174,031	211,578
Cash at bank		6,176	8,622
Total current assets		180,207	220,200
Total assets		202,208	239,026

Balance sheet

DKK'000	Note	2017/18	2016/17
Equity and liabilities			
Equity			
Share capital	12	627	560
Retained earnings		0	0
Total equity		627	560
Current liabilities			
Services in progress	10	47,403	36,907
Trade payables		15,655	19,114
Other payables		117,982	168,245
Debt to partners		20,541	14,200
Total current liabilities		201,581	238,466
Total equity and liabilities		202,208	239,026
Contractual obligations, contingencies, etc.	13		
Related party disclosures	14		
Disclosure of events after the balance sheet date	15		

Statement of changes in equity

DKK'000	Note	Share capital	Retained earnings	Total
Equity at 1 October 2016		560	0	560
Equity at 30 September 2017		560	0	560
Equity of 1 October 2017				
Cash capital increase at par		67	0	67
Transferred; see profit appropriation	8	0	0	0
Equity at 30 September 2018		627	0	627

Cash flow statements

DKK'000	Note	2017/18	2016/17
Profit for the year		0	0
Depreciation, amortisation and impairment losses		4,179	4,254
Changes in working capital	16	26,526	-17,517
Cash flow from operating activities		30,706	-13,263
Acquisition of software		-970	-685
Acquisition of equipment and leasehold improvements		-5,880	-2,052
Deposits (net change)		-504	-216
Cash flow from investing activities		-7,353	-2,953
External financing:			
Net change in financing		-32,207	-14,849
Shareholders:			
Share capital cash increase		67	0
Partner financing		6,341	14,200
Cash flow from financing activities		-25,798	-649
Cash flow for the year		-2,446	-16,865
Cash and cash equivalents at the beginning of the year		8,622	25,487
Cash and cash equivalents at year end		6,176	8,622

Notes

1. Accounting policies

The annual report of KPMG P/S for 2017/18 has been prepared in accordance with the provisions applying to reporting class C large entities under the Danish Financial Statements Act.

The accounting policies used are unchanged compared to last year, and the financial statements are presented in Danish kroner (DKK).

Foreign currency translation

On initial recognition, transactions denominated in foreign currencies are translated at the exchange rates at the transaction date. Foreign exchange differences arising between the exchange rates at the transaction date and the date of payment are recognised in the income statement as financial income or financial expenses.

Receivables, payables and other monetary items denominated in foreign currencies are translated at the exchange rates at the balance sheet date. The difference between the exchange rates at the balance sheet date and the date at which the receivable or payable arose or was recognised in the latest financial statements is recognised in the income statement as financial income or financial expenses.

Income statement

Revenue

Revenue from the sale of services is recognised in the income statement as provided. Consequently, revenue corresponds to the selling price excluding VAT of the work performed under the percentage of completion method and includes outlays on clients. Measurement at selling price presupposes that total income and costs as well as the stage of completion at the balance sheet date can be determined reliably and that it is probable that payment will be received.

Other operating income

Other operating income includes grants provided by KPMG International, gains on disposal of assets and sublease rental income.

Other external expenses

Other external costs comprise costs related to sales, marketing, administration, office premises, training, etc.

Staff costs

Staff costs comprise wages and salaries, including holiday allowance, pension and other social security costs, etc., to the Company's employees and partners, excluding reimbursements from public authorities.

Financial income and expenses

Financial income and expenses are recognised in the income statement at the amounts relating to the financial year. Financial income and expenses comprise interest income and expense, gains and losses on payables and transactions denominated in foreign currencies.

Tax on profit/loss for the year

As a limited liability partnership, the Company is transparent for tax purposes. Income taxes are liable to the partners of the Company. Consequently, no tax on the profit for the year has been provided for in the financial statements.

Balance sheet

Software

Software is measured at cost less accumulated amortisation and impairment losses. Software is amortised on a straight-line basis over the estimated useful lives. The amortisation period is usually three years.

Gains and losses on the disposal of software are determined as the difference between the selling price less selling costs and the carrying amount at the date of disposal.

Gains and losses are recognised in the income statement as other operating income or other operating costs, respectively.

Equipment and leasehold improvements

Equipment and leasehold improvements are measured at cost less accumulated depreciation and impairment losses.

Cost comprises the purchase price and any costs directly attributable to the acquisition until the date on which the asset is available for use.

The depreciable amount, which is calculated as cost less any estimated residual values at the end of the useful life, is depreciated on a straight-line basis over the estimated useful life. The estimated useful lives of equipment and leasehold improvements are 3-10 years.

Gains and losses on the disposal of equipment and leasehold improvements are stated as the difference between the selling price less selling costs and the carrying amount at the date of disposal. Gains and losses are recognised in the income statement as other operating income or other operating costs, respectively.

The carrying amount of equipment and leasehold improvements is subject to an annual test for indications of impairment other than the decrease in value reflected by depreciation.

Impairment tests are conducted of individual assets or groups of assets when there is an indication that they may be impaired. Write-down is made to the recoverable amount if this is lower than the carrying amount.

The recoverable amount is the higher of an asset's net selling price and its value in use. The value in use is determined as the present value of the forecast net cash flow from the use of the asset or the group of assets, including forecast net cash flow from the disposal of the asset or group of assets after the end of the useful life.

Receivables

Receivables are measured at amortised cost. Write-down is made for bad debt losses when there is an objective indication that a receivable has been impaired. Write-down is made on an individual basis.

Services in progress

Services in progress are measured in accordance with the percentage of completion method to the selling price of the work performed at the balance sheet date plus out-of-pocket expenses less progress billings. The individual services in progress are recognised in the balance sheet as receivables or liabilities depending on whether the net value, determined as the selling price less progress billings, is positive or negative.

Prepayments

Prepayments comprise prepayments of costs relating to subsequent financial years.

Equity

Dividends

Proposed dividends are recognised as a liability at the date on which they are adopted at the annual general meeting (declaration date). The expected dividend payment for the year is disclosed as a separate item under equity.

Corporation tax and deferred tax

The Company is transparent for tax purposes. Consequently, neither current tax nor deferred tax is included in the balance sheet.

Financial and other liabilities

Financial liabilities are recognised at the date of borrowing at cost, corresponding to the proceeds received less transaction costs paid. In subsequent periods, the financial liabilities are measured at amortised cost, corresponding to the capitalised value using the effective interest rate. Accordingly, the difference between cost and the nominal value is recognised in the income statement over the term of the loan together with interest expenses.

Other liabilities are measured at net realisable value.

Cash flow statement

The cash flow statement shows the Company's cash flow from operating, investing and financing activities for the year, the year's changes in cash and cash equivalents as well as the Company's cash and cash equivalents at the beginning and end of the year.

Cash flow from investing activities

Cash flow from investing activities comprise payments in connection with acquisitions and disposals of intangible assets, equipment and leasehold improvements and investments.

Cash flow from financing activities

Cash flow from financing activities comprise changes in the size or composition of the Company's share capital and related costs as well as payment of dividends to shareholders and raising and repayment of interest-bearing debt.

Cash and cash equivalents

Cash and cash equivalents comprise bank deposits.

Financial ratios

Financial ratios are calculated in accordance with the Danish Society of Financial Analysts' guidelines on the calculation of financial ratios "Recommendations & Ratios".

The financial ratios stated in the survey of financial highlights have been calculated as follows:

Operating margin	$\frac{\text{Operating profit/loss} \times 100}{\text{Revenue}}$
Current ratio	$\frac{\text{Current assets} \times 100}{\text{Current liabilities}}$
Return on equity	$\frac{\text{Profit/loss from ordinary activities} \times 100}{\text{Average equity}}$

2. Segment information

DKK'000	2017/18	2016/17
Revenue arises from audit and advisory services, mainly delivered in Denmark		
Audit	175,725	165,427
Advisory	331,843	258,576
	507,568	424,003

3. Staff costs

DKK'000	2017/18	2016/17
Wages, salaries and partner remuneration	334,845	310,289
Pensions	19,342	17,996
Other social security costs	2,411	2,288
	356,598	330,573
Average number of employees, including partners	410	372

The members of the Board of Directors do not receive remuneration for provision of board-related services. Pursuant to the exemption clause for reporting class C entities under section 98b(3) of the Danish Financial Statements Act, the Company has chosen to omit disclosure of executive remuneration as it would lead to disclosing remuneration to a single member of Management.

4. Fees to auditor appointed at the general meeting

DKK'000	2017/18	2016/17
Statutory audit	140	140
Tax/VAT advisory services	389	430
Other	34	33
Total fees to Redmark	563	603

5. Equipment and leasehold improvements

DKK'000	Software	Equipment and leasehold
Cost at 1 October 2017	1,597	36,735
Additions	970	5,880
Cost at 30 September 2018	2,567	42,615
Depreciation and impairment losses at 1 October 2017	-657	-31,481
Depreciation	-740	-3,439
Depreciation and impairment losses at 30 September 2018	-1,397	-34,920
Carrying amount at 30 September 2018	1,170	7,695

6. Financial income

DKK'000	2017/18	2016/17
Net foreign exchange gains	0	1,487
	0	1,487

7. Financial expenses

DKK'000	2017/18	2016/17
Interest expense to banks, etc.	632	494
Net foreign exchange losses	75	0
	707	494

8. Proposed profit appropriation

DKK'000	2017/18	2016/17
Retained earnings	0	0
Net foreign exchange losses	0	0

9. Deposits

DKK'000	Deposits
Cost at 1 October 2017	12,632
Additions	504
Cost at 30 September 2018	13,136
Carrying amount at 30 September 2018	13,136

10. Services in progress

DKK'000	2017/18	2016/17
Selling price of work performed	265,294	238,267
Progress billings	-282,272	-250,196
	-16,978	-11,929
Recognised as follows:		
Contract work in progress (assets)	30,425	24,978
Contract work in progress (liabilities)	-47,403	-36,907
	-16,978	-11,929

11. Prepayments

Prepayments consist of prepaid expenses concerning IT licences, parking, house rent, etc.

12. Share capital

Changes in share capital since the Company's establishment are specified as follows:

DKK'000	2017/18	2016/17	2015/16	2015 9 months	2013/14 13 months
Balance at 1 October	560	560	560	500	500
Cash capital increase at par	67	0	0	60	0
	627	560	560	560	500
The share capital is specified as follows:					
A shares, 291,200 of nom. DKK 1 each	291				
B shares, 336,000 of nom. DKK 1 each	336				
	627				

All shares rank equally; however, A shares that are owned by state-authorised public accountants only have a deemed majority.

13. Contractual obligations, contingencies, etc.

Operating lease obligations

Remaining operating lease obligations at the balance sheet date amount to DKK 38,954 thousand within five years (2016/17: DKK 52,017 thousand). In 2017/18, operating lease payments incurred amounted to DKK 16,442 thousand (2016/17: DKK 17,348 thousand). Contracted sub-lease income amounts to DKK 2,591 thousand, which falls due within one year (2016/17: DKK 1,636 thousand).

A company charge of DKK 20 million has been granted to the Company's bank. At the end of the year, the bank facility is unused.

14. Related-party disclosures

KPMG P/S' related parties comprise the following:

Information on controlling parties

KPMG P/S is owned by the partners. No parties exercise control.

Other related parties:

- Leadership team and Board of Directors
- KPMG Komplementarselskab ApS
- KPMG member firms including KPMG Acor Tax Partnerselskab.

Related-party transactions

The Company has chosen only to disclose transactions that are not carried out on an arm's length basis in accordance with section 98c(7) of the Danish Financial Statements Act. There are no such transactions.

15. Disclosure of events after the balance sheet date

No events materially affecting the assessment of the annual report have occurred after the balance sheet date.

16. Changes in working capital

DKK'000	2017/18	2016/17
Change in receivables	-1,824	15,360
Change in trade and other payables	28,351	-32,877
	26,526	-17,517

www.kpmg.dk



kpmg.dk

Follow us on LinkedIn and Twitter: KPMG Denmark

