



KPMG
10 Customhouse Quay
PO Box 996
Wellington 6140
New Zealand
T: +64 4 816 4500

Our ref: 9476121_1.docx

Addressing Hybrid Mismatches
c/-Deputy Commissioner, Policy and Strategy
Inland Revenue Department
P O Box 2198
Wellington 6140
Policy.webmaster@ird.govt.nz

3 November 2016

Dear Sir/Madam

We welcome the opportunity to respond to the *Addressing Hybrid Mismatches – A Government Discussion Document* ("the DD"). We also appreciate the ability for ongoing constructive dialogue with Officials on this complex area.

Adopting a global programme for New Zealand

We understand and appreciate that the BEPS programme is a global programme. It relies on global implementation. However, the Action 2 recommendations raises the need to balance two competing perspectives.

- Embracing the OECD's recommendations will align New Zealand with some other countries and meet perceived community expectations. This will make New Zealand a good global citizen with a fair tax system.
- Rejecting the OECD recommendations will retain the coherence and sovereignty of New Zealand's tax system and maximise foreign investment in New Zealand.

Both perspectives need to be considered against the fiscal impact of the proposals.

The DD concludes that a comprehensive approach will likely be in New Zealand's national interest. We are not convinced that the case has been sufficiently robustly made. We consider that the DD over-estimates the revenue at risk from failing to adopt the recommendations and the revenue that will be collected as a result of adopting the rules.

We acknowledge that it is possible to reasonably disagree on the balance between the competing perspectives. However, much of what is proposed in the document goes too far, too fast.

We consider that New Zealand should proceed with caution. It should adopt measures clearly in New Zealand's overall interests. This is not to say that there is no need for reform but it should be selective. It should seek to protect existing rules which make sense for New Zealand's tax system. Otherwise, it risks incoherence and reduced revenue and investment.

New Zealand's tax system

New Zealand's tax policy generally follows a principled approach. The Tax Working Group's conclusion that New Zealand's tax system is generally coherent and works well is correct. Disagreements on where the relevant boundaries should be drawn does not change that

conclusion. As they are subject to on-going consultation and review, they are evidence of the good health of the tax system generally.

Generally, New Zealand's tax system:

- Draws the boundary between debt and equity and opaque and transparent entities on a thought out, principled basis;
- Considers company tax as a withholding tax (although that is sometimes conveniently ignored in cross-border scenarios) given the imputation regime;
- Aligns tax rates and systems so that double taxation is minimised;
- Applies a broad based consumption tax; and
- Does not seek to advantage or disadvantage particular behaviours or investments.

Comparing New Zealand with the OECD's programme

Implementation of the BEPS recommendations needs to be carefully considered. The proposals need to be evaluated on a principled basis which is consistent with New Zealand's tax regime. A "New Zealand should adopt it because the OECD has recommended it" approach is not sufficient justification for proceeding and certainly not at speed.

This is particularly the case because the OECD recommendations can be best described as pragmatic. A principled approach would recommend clear debt/equity and opaque/transparent entity borders. It would also limit the potential for double taxation rather than encouraging it.

The OECD recommendations do not specifically take a principled approach. As the DD acknowledges, that is not possible. Instead it recommends tax rules which produce de facto borders and allow double taxation.

Applying the recommendations therefore risks generating incoherent outcomes for the tax system.

The risk factors

This risk is in our view compounded by a number of factors.

Are some of the results in the DD really a hybrid mismatch concern?

The proposals are wide ranging. They question fundamental outcomes of regimes which have been tested through the full generic tax policy process. These regimes achieve what New Zealand wants them to achieve. These are deliberate outcomes.

The proposals will change those outcomes because of decisions made, and not made, by other countries. In some cases with the only apparent justification that the OECD has recommended the rules.

In our view, the results of New Zealand's regimes are defensible from an anti-hybrid mismatch perspective. For example, see the characterisation of the FITC regime referenced in a DD footnote. This shows it is possible to analyse regimes to show they do not provide a hybrid mismatch result. The DD does not appear to do this analysis for any other regimes. New Zealand should consider how its regimes are properly characterised to confirm a hybrid mismatch result and the need for action.

The fiscal impact of the proposals – positive for New Zealand?

The policy justification (in Part 1 of the DD) is that a globally consistent implementation of the proposals will even the global playing field for investment. New Zealand will benefit from a reduced global incentive to use hybrid mismatches. The analysis and justification is brief and qualified. It is focused on “greenfield” investment. It does not appear to consider potential downstream impacts. The net benefits for New Zealand are therefore uncertain.

The analysis assumes the proposals will be neutral or positive for New Zealand’s fiscal position. Hybrid arrangements are assumed to be replaced by equity capital, rather than debt. This assumption needs to be tested, particularly as use of replacement debt may be at higher interest rates.

Cost of capital and compliance costs

New Zealand will generally deny deductions for inbound hybrid financing under the proposals. This will impose additional costs on domestic factors. This includes the substantive loss of tax deductions. It will also require evaluating whether a funding arrangement gives rise to a hybrid mismatch outcome. This will require knowledge of how other countries will tax the arrangement. The compliance costs on borrowers and investors, due to the wide “structured arrangement” definition proposed, should not be underestimated. This is a practical issue.

Other countries’ implementation and approach matters to New Zealand’s position

Most other countries’ tax regimes seek to achieve trade, jobs and fiscal revenue objectives. The BEPS project received political support as, globally, Government revenues were under pressure following the global financial crisis. However, this does not remove the trade and jobs objectives of other countries’ tax regimes. Individual countries will continue to make choices for those, and not just pure tax policy, reasons.

For example, refer the United Kingdom, which has introduced hybrid mismatch rules but at the same time a concessionary “patent box” tax regime to attract technology businesses. The US appears unlikely to adopt any BEPS proposals it considers will adversely impact its multinationals operating globally. (The US Treasury response to the European Commission State Aid Ruling against Ireland is potentially illustrative of its likely position.)

We therefore expect implementation to be inconsistent and ad hoc, based on political economy. Not all major economies will follow suit.

The DD focuses on Australia, the UK and in part the EU. The DD does not explore the reasons why these countries have decided to progress with implementation. Our expectation, based on publically available information, is they have decided that the hybrid mismatch rules are fiscally positive for them. This suggests fiscal self-interest rather than global co-ordination providing welfare benefits is the driver.

Even for those countries which the DD considers will implement the rules, the DD does not draw the conclusion that New Zealand’s adoption of the rules may be moot. In our view, the New Zealand fiscal position from implementing the rules is much less clear. In fact, our expectation is that the rules may negatively impact the fiscal position.

The DD ignores the position of major investing and trading partners for New Zealand. It therefore does not present a complete picture.

The impact on commercial arrangements

We understand the expectation is that implementation of the proposals will mean there are no hybrid mismatches. The proposals are prophylactic. That may be the case for intra-group structured arrangements which are perceived to have little substance. However, those arrangements appear to already be dealt with by New Zealand’s tax system.

Further, the proposals go beyond such related party arrangements. The DD appears to target every possible mismatch, without properly considering whether a hybrid response is justified. We note specifically the sections which deal with FIF mis-matches as an example. Implementation will therefore affect commercial arrangements.

Full consideration of the consequences cannot be done in the time allowed

Finally, the time allowed for consideration has been insufficient to fully and coherently consider the impact of the proposals. The proposals question the outcomes for many and varied New Zealand tax regimes. In our view, the justification for many of the proposals is lacking.

Further, the flow on consequences do not appear to have been fully considered. For example:

- Is the FIF regime sustainable if the FIF regime is considered to produce hybrid results?
- Will the hybrid rules adversely affect the application of New Zealand's General Anti-Avoidance Rule?
- How do the recommendations overlap so that they can be simplified?
- What opportunities are there to improve New Zealand's rules if the recommendations are implemented?

There is a real sense that this is too far too fast.

Principal recommendation: a phased approach is supported

A better approach would be to consider discrete parts of the Action 2 recommendations by identifying the hybrid arrangements that are most pressing for New Zealand's tax base. This would allow:

- more time to consider the impact and implementation of the remaining recommendations;
- New Zealand to better assess the prospects for other countries to implement the recommendations and therefore the need to implement complex rules with wide application and uncertain effect.

Our recommendation is therefore for a phased approach.

Approach to detailed submissions

These general comments and submissions underlie our detailed comments and observations.

Given the very short timeframe, the breadth of the proposals and uncertainty as to their impact, we have taken the approach of providing detailed comments and responses directly on a word version of the DD. (They are identified by underlining and labelling as **KPMG Comment**.)

We have left the detailed comment section of our submission in draft. This recognises the complexity of the proposals – we may have misunderstood what is being proposed.

We acknowledge the comments may not present a coherent response across the range of recommendations. That is a function of the time available, the range of issues and uncertainty as to what is being proposed and its impact in some cases. Our recommended phased approach will provide a better opportunity to provide a more coherent response.

We trust that our approach encourages continued discussion and makes it easier to match the submission to the proposal.



Inland Revenue

3 November 2016

We would be pleased to discuss our submissions. Please contact John on 04 816 4518.

Yours sincerely

A handwritten signature in blue ink that reads 'John Cantin'.

John Cantin
Partner

Yours sincerely

A handwritten signature in blue ink that reads 'D. Elwela'.

Darshana Elwela
National Tax Director

Addressing hybrid mismatch arrangements

A Government discussion document

KPMG Comment and Observations

3rd November 2016

Hon Bill English
Minister of Finance

**Hon Michael
Woodhouse**
Minister of Revenue



First published in September 2016 by Policy and Strategy, Inland Revenue,
PO Box 2198, Wellington 6140.

Addressing hybrid mismatch arrangements – A Government discussion document.
ISBN 978-0-478-42436-2

CONTENTS

Introduction	1	
PART I	3	
Policy and principles		3
CHAPTER 1	5	
Background	5	
	Historic focus on the problem of double taxation	5
	The problem of double non-taxation	5
	G20/OECD Action Plan	6
	Hybrid mismatch arrangements	6
	OECD recommendations	7
	Implementation of OECD recommendations	8
CHAPTER 2	9	
Hybrid mismatch arrangements		9
	Hybrid instruments	11
	Hybrid entities	15
	Indirect outcomes	18
CHAPTER 3	20	
Policy issues	20	
	Global impact of hybrid mismatch arrangements	20
	Uptake in other countries	25
	Impact of hybrid mismatch arrangements on New Zealand	26
CHAPTER 4	32	
OECD recommendations		32
	Hybrid mismatch rules – OECD recommendations	33
	Double tax agreement commentary	38
	Submissions on Part I	39
PART II	40	
Details of OECD recommendations		40
CHAPTER 5	41	
Hybrid financial instruments		41
	Recommendation 2	41
	Recommendation 1	44
	Particular tax status of counterparty not relevant	47
	Differences in valuation of payments not relevant	47
	Timing differences	47
	Taxation under other countries' CFC rules	48
	Application of rule to transfers of assets	49
	Regulatory capital	52
	Other exclusions	52
	Application to New Zealand	52
CHAPTER 6	62	
Disregarded hybrid payments		62

	Requirements for rule to apply	62
	Dual inclusion income	63
	Carry-forward of denied deductions	65
	Application of CFC regimes	66
	Implementation issues	66
	Application to New Zealand	67
CHAPTER 7	69	
Reverse hybrids	69	
	Recommendation 4	70
	Recommendation 5	71
	Application in New Zealand	71
	Recommendation 5.3: Information reporting	77
CHAPTER 8	79	
Deductible hybrid payments	79	
	Application to New Zealand	80
CHAPTER 9	82	
Dual resident payers	82	
	Application to New Zealand	82
	DTA dual resident rule suggestion	83
CHAPTER 10	85	
Imported mismatches	85	
	Non-structured imported mismatches	86
	Application to New Zealand	86
CHAPTER 11	88	
Design principles, including introduction and transitional rules	88	
	Design and interaction	88
	General rule for introduction	95
	Co-ordination with other countries	96
CHAPTER 12	98	
Key definitions	98	
	Financial instrument	98
	Structured arrangement	98
	Related persons	100
	Control group	101
	Payment	102

Introduction

Hybrid mismatch arrangements are one of the main base erosion and profit shifting (BEPS) strategies used by some large multinational companies to pay little or no tax anywhere in the world. As such, the OECD has developed recommendations for anti-hybrid measures in its 15 point Base Erosion and Profit Shifting (BEPS) Action Plan.

Hybrid mismatch arrangements exploit the different ways that jurisdictions treat financial instruments and entities to create tax advantages. Because countries have different tax systems, misalignment of domestic rules is inevitable. The OECD recommendations attempt to prevent this misalignment from giving rise to unintended tax advantages. This is primarily done through the use of “linking rules” which change the usual tax treatment of cross-border transactions to ensure that there is no hybrid mismatch in such cases.

Since hybrid mismatch arrangements are not necessarily artificial or contrived, the OECD recommendations are targeted at deliberate exploitation of hybrid mismatches. To achieve this, the proposed rules generally only apply to cross-border transactions involving related parties, as well as unrelated parties if the arrangement has been deliberately structured to produce a hybrid mismatch advantage.

If New Zealand were to adopt the OECD anti-hybrids recommendations, the rules would apply to foreign companies doing business in New Zealand as well as New Zealand-owned companies doing business offshore.

It is expected that most hybrid arrangements would be replaced by more straightforward (non-BEPS) cross-border financing instruments and arrangements following the implementation of the OECD recommendations in New Zealand.

Rules to counteract hybrid mismatch arrangements have been introduced in a number of countries. Notably, Australia and the UK are in the process of implementing the OECD recommendations into their domestic law. In addition, the European Council has issued a directive requiring EU member states to introduce anti-hybrid rules (currently on an intra-EU basis but expected to include arrangements involving non-EU countries in the future).

The purpose of this document is to seek comments on how the OECD recommendations could be implemented in New Zealand. Final policy decisions will only be made after the consultation phase. Part I of the document describes the problem of hybrid mismatch arrangements, the case for responding to the problem, and a summary of the OECD recommendations. Part II of the document explains the OECD recommendations in greater depth and discusses how they could be incorporated into New Zealand law.

Submissions

The Government seeks submissions on how the OECD recommendations should best be incorporated into New Zealand law.

Submissions should include a brief summary of major points and recommendations and should refer to the document's labelled submission points where applicable. They should also indicate whether it would be acceptable for Inland Revenue and Treasury officials to contact those making the submission to discuss the points raised, if required.

Submissions should be made by 17 October 2016 and can be emailed to policy.webmaster@ird.govt.nz with "Addressing hybrid mismatch arrangements" in the subject line.

Alternatively, submissions may be addressed to:

Addressing hybrid mismatch arrangements
C/- Deputy Commissioner, Policy and Strategy
Inland Revenue Department
PO Box 2198
Wellington 6140

Submissions may be the subject of a request under the Official Information Act 1982, which may result in their release. The withholding of particular submissions, or parts thereof, on the grounds of privacy, or commercial sensitivity, or for any other reason, will be determined in accordance with that Act. Those making a submission who consider that there is any part of it that should properly be withheld under the Act should clearly indicate this.

In addition to seeking written submissions, Inland Revenue and Treasury officials intend to discuss the issues raised in this discussion document with key interested parties.

PART I

Policy and principles

CHAPTER 1

Background

Historic focus on the problem of double taxation

- 1.1 The global international tax framework reflected in international tax treaties and countries' domestic tax rules recognises that income earned from cross-border activities is at risk of double taxation – once in the country where it is earned (the source state) and once in the country where the entity deriving the income is resident (the residence state).
- 1.2 Co-operation among countries regarding income taxation has been mostly concerned with this risk of double taxation – when an item of income is taxed under the domestic law of both the source and residence states and its harmful effects on cross-border trade and investment. The principal focus of international tax treaties has been on eliminating double taxation through allocating taxing rights over cross-border income between the residence and source states.

The problem of double non-taxation

- 1.3 Since late 2012, there has been growing awareness that the combination of different domestic tax rules and tax planning allows multinationals to pay little or no tax on their income anywhere in the world, if they choose to do so. This so-called double non-taxation (or less than single taxation) raises a number of tax policy issues. Many of the issues raised, such as distortionary effects and competitive concerns, are similar to those raised by double taxation.
- 1.4 The wide range of international tax planning techniques that are used to achieve double non-taxation are collectively referred to as “base erosion and profit shifting” or “BEPS”. As BEPS strategies take advantage of weaknesses in the current international tax framework and/or gaps or mismatches that result from the interaction of the tax systems of different countries,¹ it is impossible for any single country, acting alone, to fully address the issue. Recognising this, the OECD and G20 have taken the lead on work in this area, with the aim of developing a co-ordinated global approach to addressing BEPS concerns.

KPMG Comment: Paragraphs 1.2 to 1.4 and footnote 1 highlight a fundamental problem with the BEPS project – a failure to agree/achieve consensus on what is the true source of income.

In a hybrid capital mis-matches context this means focusing on the allocation of income for equity and debt.

¹ The issues coalesce such that rules developed to allocate income among countries can be manipulated to shift income away from its “true” source to low tax countries.

Income is generally apportioned between the source and the use of the debt. Income is allocated to where equity is used as no deduction is allowed for the return on equity. Notably, no income is allocated to the country which provides equity capital.

Double taxation arises when there is no deduction for the return on equity and that return is taxed. The standard solution to the double taxation problem is to exempt income from equity in the capital providing country. This allows mis-matches in debt/equity treatment.

The fundamental problem is not the mis-match but the lack of a consensus on the allocation of the “true” source of income from equity. The OECD recommendations deal with this problem by further allocating income to the country where the capital is used.

This creates double taxation, at a minimum at the ultimate shareholder level, but also because it allows company and withholding tax to be applied.

G20/OECD Action Plan

- 1.5 The OECD approach has been to develop specific recommendations for countries to implement, either through changes to their domestic laws, through treaty provisions, or multilaterally. The aim has been to give countries the tools necessary to ensure that profits are taxable, and taxable where the economic activities generating the profits are performed and where value is created. The OECD released an Action Plan on BEPS on 20 July 2013, containing a comprehensive package of measures to address BEPS concerns.² New Zealand has participated in the Action Plan work and supported it, particularly the intention that a co-ordinated global approach be taken to addressing BEPS concerns. The final BEPS package of recommendations was released on 5 October 2015, approved by G20 finance ministers on 9 October 2015, and by G20 leaders during their annual summit on 15–16 November 2015.

KPMG Comment: See our comment on the previous paragraphs.

Hybrid mismatch arrangements

- 1.6 Hybrid mismatch arrangements are identified in the Action Plan as an important source of BEPS concerns. Action 2 of the Action Plan aims to neutralise their effects by developing model treaty provisions and recommendations regarding the design of domestic tax rules.
- 1.7 Hybrid mismatch arrangements exploit differences in the tax treatment of an entity or instrument under the laws of two or more countries to achieve double non-taxation (including long-term tax deferral) by, for example, creating two deductions for one borrowing or creating a deduction without a corresponding income inclusion. Mostly, the tax result comes from a mismatch of domestic laws, but double tax agreements can be used to enhance the tax benefit by, for

² OECD (2013), *Action Plan on Base Erosion and Profit Shifting*, OECD Publishing. <http://dx.doi.org/10.1787/9789264202719-en> (OECD BEPS Action Plan).

example, eliminating or reducing source state withholding taxes. It is often difficult to determine which of the countries involved has lost tax revenue, but there is a reduction of total tax paid.

- 1.8 With many hybrid mismatch arrangements involving New Zealand taxpayers, the exploited mismatch is between New Zealand and Australia's domestic rules. For example, a number of New Zealand taxpayers have been involved in recent tax avoidance litigation with the Commissioner of Inland Revenue (the Commissioner), which concern funding arrangements that exploit the different tax treatment between Australia and New Zealand of optional convertible notes (a hybrid financial instrument) issued by the New Zealand taxpayer to their Australian parent. Similarly, tax disputes have arisen between New Zealand taxpayers and the Commissioner over the tax effects of arrangements that exploit the different ways in which Australia and New Zealand treat Australian limited partnerships.

KPMG Comment: The hybrid mismatch, at least for the OCN, has been countered through New Zealand Court decisions. Officials have previously concluded that those decisions remain effective. (See Officials Report on the benefits of hybrid financing for New Zealand.) This suggests that, at least for this concern, a further domestic response is not required.

OECD recommendations

- 1.9 As part of a first set of deliverables under the Action Plan, the OECD released a paper containing recommendations regarding hybrid mismatch arrangements in September 2014.³ A final report was released in October 2015,⁴ as part of the final BEPS package, containing further work on various remaining technical issues, and additional guidance and practical examples explaining the operation of the recommendations in further detail. The recommendations are for specific improvements to domestic rules to prevent mismatches arising and neutralise their effect, and for changes to the OECD Model Tax Convention⁵ to deal with hybrid entities, and the interaction between domestic rules and the OECD Model. The recommended hybrid mismatch rules are primarily linking rules that seek to align the tax treatment of a hybrid entity or instrument with the tax treatment in the counterparty country, but do not otherwise disturb the commercial outcomes.
- 1.10 New Zealand already has some rules that deter and prevent hybrid mismatch arrangements from arising. However, the OECD recommendations on hybrid mismatch arrangements are comprehensive by comparison.

³ OECD (2014), *Neutralising the Effects of Hybrid Mismatch Arrangements*, OECD/G20 Base Erosion and Profit Shifting Project, OECD Publishing. <http://dx.doi.org/10.1787/9789264218819-en> (OECD 2014 Interim Report).

⁴ OECD (2015), *Neutralising the Effects of Hybrid Mismatch Arrangements, Action 2 – 2015 Final Report*, OECD/G20 Base Erosion and Profit Shifting Project, OECD Publishing, Paris. <http://dx.doi.org/10.1787/9789264241138-en> (OECD 2015 Final Report).

⁵ OECD (2014), *Model Tax Convention on Income and on Capital: Condensed Version 2014*, OECD Publishing. http://dx.doi.org/10.1787/mtc_cond-2014-en (OECD Model).

Implementation of OECD recommendations

- 1.11 With the release of the Final Report, along with the Action Plan as a package of recommendations, governments will now look to implement the results into their domestic rules. Although it remains to be seen where different countries will land in terms of implementation, there is an expectation that countries that are part of the consensus will act.
- 1.12 The United Kingdom and Australia have both already committed to implementing the OECD recommendations into their domestic law. In addition, EU member states have been issued a directive to implement anti-hybrid measures for transactions between EU members, with further action on rules applying to non-EU countries expected later this year.

***KPMG Comment:** The document does not address the position of the United States of America. Its position is significant for the global economy and global tax policy. We refer simply to publically available information on the USA's position on EU efforts to counter the "transfer of income from where it is truly sourced" as perceived by the EU but not by the USA. Refer the US Treasury response to the recent European Commission's State Aid decision against Ireland.*

We also note that the EU's position is itself not a settled position. We refer to Ireland's response to the same EU State Aid decision.

In both cases, the response is consistent with our view that BEPS is about trade, jobs and tax policy because most countries will develop tax policy with regard to all three, not just the purity of tax policy. Taking the OECD's position and any particular country's view at face value is risky for New Zealand which traditionally has considered tax policy from a "purer" perspective.

CHAPTER 2

Hybrid mismatch arrangements

2.1 A “hybrid mismatch arrangement”, as defined by the OECD:⁶

... exploits a difference in the tax treatment of an entity or instrument under the laws of two or more tax countries to produce a mismatch in tax outcomes where the mismatch has the effect of lowering the aggregate tax burden of the parties to the arrangement.

KPMG Comment: We note that the definitions proposed in Chapter 12 may, in our view, go beyond arrangements which exploit differences.

We further note that the BEPS project does not acknowledge that domestic tax laws are generally deliberately drawn to achieve tax and other policy outcomes. We acknowledge that while this may not always be true, it should generally be true of countries with mature tax policy development processes.

New Zealand is in our view such a country. It should certainly be true of countries with sophisticated Revenue Authorities. We would count New Zealand and many of its trading partners as qualifying but note this is a subjective analysis. Therefore, where a country has adopted particular parameters such as legal form over substance for debt/equity treatment, these will be the result of specific domestic tax policy decisions.

The hybrid proposals presume these choices give rise to sub-optimal outcomes in need of remedy. However, this is potentially at the cost of fundamentally disrupting the original policy drivers and existing commercial arrangements.

Where sophisticated Revenue Authorities have not been able to have the line legislatively drawn to their satisfaction, a country implementing the OECD recommendations will overrule the other country’s deliberate and in most cases democratically made domestic tax policy decisions.

At Paragraph 1.8 the document refers to the mis-match in Australia’s and New Zealand’s laws. There would be very few who would consider Australia unsophisticated in tax policy terms or in aggressively pursuing its position. To the extent that the OECD report assumes that Australia is unable to look after itself, that is clearly an incorrect assumption. Rather, the mismatch is an outcome of the lack of global consensus on debt/equity and

⁶ OECD 2014 Interim Report at para 41.

entity treatments. The recommendations deal with this problem indirectly and potentially incoherently.

We have taken the use of “exploits” as a pejorative term. It may be intended to be descriptive – that this is an outcome that arises. In that case, where deliberate policy decisions have been made, it is less obvious that a response is required.

2.2 Thus, a taxpayer with activities in more than one country may have opportunities to escape taxation through the use of hybrid mismatch arrangements.

2.3 In the vast majority of cases, the tax outcome comes from a mismatch of domestic laws. However, double tax agreements can be used to enhance a tax benefit (for example, via the elimination or reduction of withholding taxes at source). The use of hybrid mismatch arrangements puts the collective tax base of countries at risk, although it is often difficult to determine which individual country has lost tax revenue under an arrangement.

KPMG Comment: It makes sense for New Zealand to attempt to determine whether it is its revenue which is lost. It appears that the Government has not done the work to make this assessment (see the last sentence of Paragraph 2.3).

If the expectation, that non-hybrid arrangements are used, is realised, we would expect that New Zealand as a net capital importer will raise less revenue. We assume debt with a higher interest rate and not equity will be the replacement funding.

Given that New Zealand may well lose revenue, we consider that work to confirm the revenue position should be done before proceeding.

2.4 Action 2 of the OECD Action Plan on Base Erosion and Profit Shifting (BEPS) calls for domestic rules targeting mismatches that rely on a hybrid element to produce the following three tax advantage outcomes:⁷

- *Deduction no inclusion (D/NI):* Payments that give rise to a deduction under the rules of one country but are not included as taxable income for the recipient in another.
- *Double deduction (DD):* Payments that give rise to two deductions for the same payment.
- *Indirect deduction no inclusion (indirect D/NI):* Payments that are deductible under the rules of the payer country and where the income is taxable to the payee, but offset against a deduction under a hybrid mismatch arrangement.

2.5 The mismatches targeted are those arising in the context of payments as opposed to, for example, a mismatch arising from rules that allow a taxpayer “deemed” interest deductions for equity capital.

⁷ OECD 2015 Final Report at para 6.

KPMG Comment: *It is unclear what the implication of this statement is for New Zealand's adoption of the recommendations. Will New Zealand be able to target "deemed" interest deductions for denial of a deduction? This is obviously key to determining whether there is a New Zealand fiscal benefit or not.*

2.6 In broad terms, hybrid mismatch arrangements can be divided into the following categories based on the particular hybrid technique that produces the tax outcome:

- *Hybrid instruments* exploit a conflict in the tax treatment of an instrument in two or more countries. These arrangements can use:
 - *Hybrid financial instruments*, under which taxpayers take mutually incompatible positions regarding the treatment of the same payment under the instrument;
 - *Hybrid transfers*, under which taxpayers take mutually incompatible positions regarding who has the ownership rights in an asset; or
 - *Substitute payments*, under which a taxable payment in effect becomes non-taxable by virtue of a transfer of the instrument giving rise to it.
- *Hybrid entities* exploit a difference in the tax treatment of an entity in two or more countries (generally a conflict between transparency and opacity).

2.7 Hybrid entities and instruments can be embedded in a wider arrangement or structure to produce indirect D/NI outcomes.

Hybrid instruments

Hybrid financial instruments

2.8 A simple arrangement involving the use of a hybrid financial instrument is set out below.

Figure 2.1: Hybrid financial instrument⁸

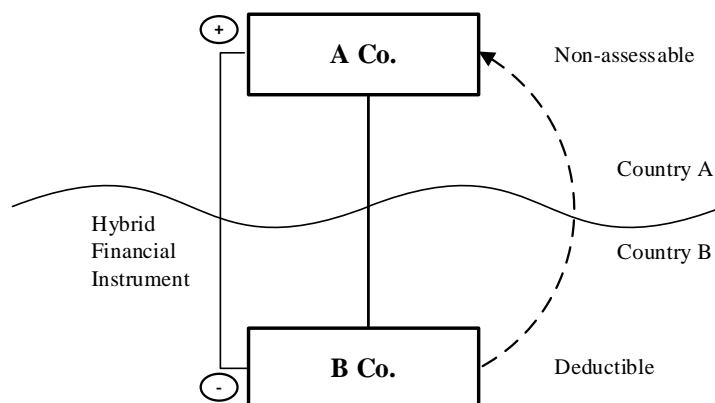

- 2.9 Under the arrangement, B Co (resident in Country B) issues a hybrid financial instrument to its parent A Co (resident in Country A). Country B treats the instrument as debt, so that payments under the instrument are treated as deductible interest to B Co. Country A treats the instrument as equity, so that payments under the instrument are treated as exempt dividends (or otherwise tax relieved) to A Co. The tax outcome is D/N.I.
- 2.10 A number of New Zealand taxpayers have had recent involvement in tax avoidance litigation with the Commissioner of Inland Revenue regarding their use of hybrid financial instruments in funding arrangements with their offshore parents.
- 2.11 In *Alesco New Zealand Ltd v Commissioner of Inland Revenue*,⁹ the New Zealand Court of Appeal considered one such arrangement as a test case. The New Zealand taxpayer had issued optional convertible notes to its Australian parent; treated as part debt and part equity in New Zealand, but exclusively equity in Australia. Outside of tax avoidance, the tax outcome was D/N.I: a New Zealand deduction for the interest notionally paid by the New Zealand taxpayer on the debt component of the notes,¹⁰ but no interest income to the Australian parent for which it would otherwise have been liable for Australian taxation. The Court of Appeal’s holding that the arrangement was tax avoidance was not based on the Australian tax treatment.

KPMG Comment: *The document does not consider the effect of alternative funding and its effect on New Zealand’s tax revenue. The Alesco OCN would seem to be a good case study. In that case, Alesco argued that the counterfactual – use of vanilla debt – would have resulted in the same or lesser tax outcomes for New Zealand.*

We note that Officials appear to be of the view that equity funding will replace hybrid debt funding. This is supported by analysis which says that debt funding into NZ is typically less than the safe harbour thin capitalisation rules. That is not unexpected. Additional debt is not

⁸ OECD 2014 Interim Report at p33.

⁹ *Alesco New Zealand Ltd v Commissioner of Inland Revenue* [2013] NZCA 40, [2013] 2 NZLR 175.

¹⁰ With no New Zealand non-resident withholding tax (NRWT) liability.

readily introduced into New Zealand after the initial investment. Over time, the debt level can be expected to decrease as a percentage.

However, our experience is that debt levels, at the time of investment, will approach the thin capitalisation safe harbour rate. The effect of New Zealand tax on the marginal investment has been the focus of tax policy. We consider debt, and not capital funding, is the better comparator. Simple debt is likely to attract higher interest and also higher cash outflows from New Zealand. This is likely to lead to both lower fiscal revenue and also lower capital retained in New Zealand.

- 2.12 Apart from taxpayers formally bound by the *Alesco* ruling, a number of New Zealand taxpayers have, in recent times, entered into arrangements under which they have issued mandatory convertible notes (MCNs) to their offshore parents. Commonly, interest is accrued over the term of the arrangement, and at maturity, the issuer's interest obligation is satisfied by issuing shares. As New Zealand treats the MCN as debt, the arrangement gives rise to deductible interest to the New Zealand issuer,¹¹ but the issue of shares to satisfy the New Zealand issuer's interest obligation does not result in income to the offshore parent (that is, D/NI).
- 2.13 The Commissioner has challenged a number of the arrangements using MCNs as tax avoidance arrangements. Under recent Australian domestic rule changes, a D/NI outcome can potentially now be achieved using an MCN with cash interest payments. Previously, Australia's non-portfolio foreign dividend exemption would not have applied had cash interest (rather than the issue of shares) been paid under the MCN, because an MCN is not legal form equity.¹² Now, such payments would likely be exempt in Australia;¹³ the amendments ensure that Australia's non-portfolio foreign dividend exemption applies to returns on instruments that are legal form debt but that Australia characterises as equity, as a matter of substance, under its debt-equity rules.¹⁴

KPMG Comment: See our comments at Paragraph 2.11.

- 2.14 A third common form of trans-Tasman hybrid financial instrument is frankable/deductible instruments issued by the New Zealand branch of some Australian banks to the Australian public.¹⁵ Typically, these instruments qualify as bank capital for Australian regulatory purposes. As with the MCNs, the bank issuer claims a New Zealand tax deduction for the coupon on these instruments. The Australian tax treatment is different. The instruments are treated as equity for Australian tax purposes, but because they are held by portfolio investors, the return is taxable. However, the bank attaches franking credits to the coupon. The credits work in the same way as New Zealand imputation credits. The credits are not generated by the investment of the funds raised by issue of the

¹¹ And no New Zealand NRWT obligation. **KPMG Comment:** It is not clear why this result is obtained, the issue of shares to satisfy the interest would appear to still be interest (albeit it is not in cash).

¹² Section 23AJ of the Australian Income Tax Assessment Act 1936 – repealed under item 1 of Part 1, Schedule 2 to the Tax and Superannuation Laws Amendment (2014 Measures No. 4) Act 2014.

¹³ Although *prima facie* subject to New Zealand non-resident withholding tax. **KPMG Comment:** It is not clear why the two qualifications are included, i.e. "Although prima facie...?"

¹⁴ The Tax and Superannuation Laws Amendment (2014 Measures No. 4) Act 2014 received Royal assent on 16 October 2014. The relevant provisions apply the day after Royal assent: section 2 and Part 4 of Schedule 2.

¹⁵ See *Mills v Commissioner of Taxation* [2012] HCA 51.

instruments – because that income is earned by the New Zealand branch of the Australian bank it is not subject to Australian income tax. So the Australian bank obtains a New Zealand income tax deduction for a payment which for Australian tax purposes is treated in the hands of the payee as made out of fully (Australian) taxed income.

- 2.15 This type of instrument is considered in Example 2.1 of the Final Report, which concludes that it gives rise to a hybrid mismatch.

KPMG Comment: See our comments at Paragraph 2.11. Further, such instruments would typically reduce the interest rate by the franking credits attached. This, by definition, means that New Zealand will lose revenue from any replacement debt financing. (We would not expect such a branch to be capital funded in New Zealand. Capital funding would be raised outside New Zealand so that franking credits can be attached.)

Hybrid transfers

- 2.16 A simplified arrangement involving a hybrid transfer is set out in Figure 2.2.
- 2.17 Typically, a hybrid transfer is a collateralised loan arrangement or share lending transaction where the counterparties in different countries are each treated for tax purposes as the owner of the loan collateral or subject matter of the share loan. In the arrangement set out in the figure below, the mismatch arises because Country A taxes the arrangement in accordance with its economic substance (a loan with the shares as collateral), while Country B (like New Zealand) taxes in accordance with the arrangement’s legal form (a sale and repurchase or “repo” of the shares).

Figure 2.2: Hybrid transfer – share repo¹⁶

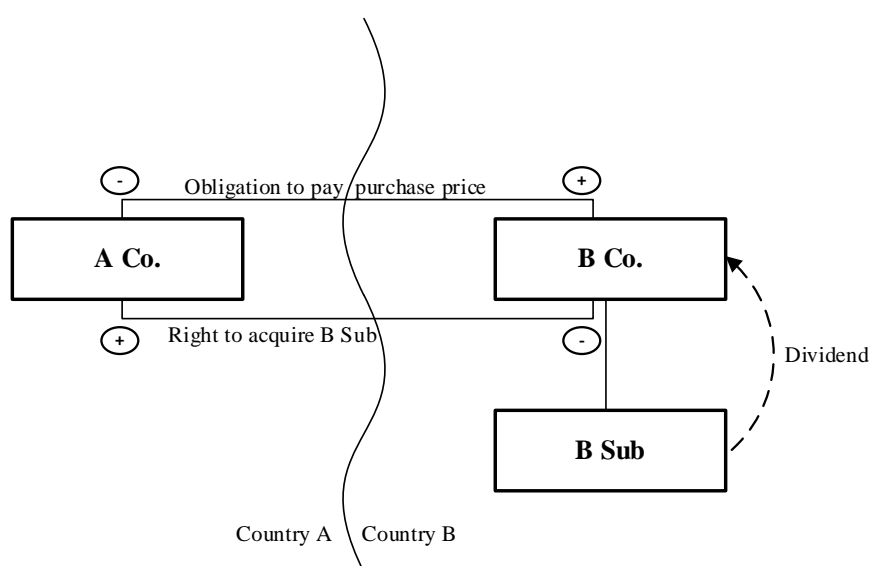

- 2.18 A Co (resident in Country A) owns B Sub (resident in Country B). A Co sells its B Sub shares to B Co under an arrangement that A Co will reacquire those

¹⁶ OECD 2014 Interim Report at p35.

shares at a future date for an agreed price reflecting an interest charge reduced by any dividends B Co receives on the B Sub shares. Between sale and repurchase, B Sub pays dividends on the shares to B Co. In Country A, A Co is treated as receiving these dividends and paying them to B Co as a deductible financing cost. In Country B, B Co is treated as receiving the dividends, which are tax exempt. The tax effect is D/NL.

Hybrid entities

Disregarded payments made by a hybrid payer

- 2.19 A simplified arrangement involving the use of a hybrid entity to achieve a D/NL outcome is set out in Figure 2.3.

Figure 2.3: Disregarded payments made by a hybrid entity¹⁷

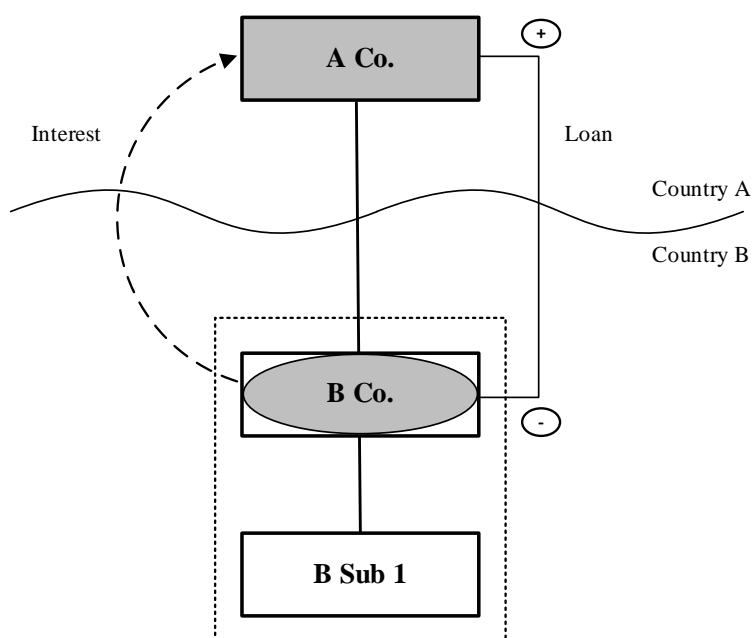

- 2.20 A Co (resident in Country A) indirectly holds B Sub 1 (resident in Country B) through B Co, a hybrid entity treated as transparent in Country A, but opaque in Country B. B Co borrows from A Co, and pays interest on the loan, which is treated as deductible in Country B. The deduction can be used to offset income in B Sub 1's group of companies in Country B. As Country A treats B Co as transparent (and as A Co is the only shareholder in B Co), the loan, and interest on the loan, between A Co and B Co, is disregarded in Country A (that is, a D/NL result).¹⁸
- 2.21 New Zealand unlimited liability companies are used to play the role of B Co in the figure above to achieve a D/NL (inbound) outcome. The United States'

¹⁷ OECD 2014 Interim Report at p42. The tax outcomes of the arrangement are described at paras 73–74. This structure is also at the core of Example 3.1 of the OECD 2015 Final Report at p288.

¹⁸ The treaty implications relate to whether, and to what extent, Countries A and B are limited by the relevant treaty in taxing the income of A Co. Under the OECD Model, an amount arising in Country B is paid to a resident of Country A, so, *prima facie*, the benefits of Article 11 (Interest) would be granted.

domestic “check the box” rules allow a New Zealand unlimited liability company, treated as opaque by New Zealand, to be treated as transparent for United States income tax.

KPMG Comment: Given public statements, it seems unlikely that the US will adopt comprehensive hybrid mismatch rules. Their application in New Zealand will result in the primary rule (denial of interest deductions) applying to financing provided via US “check the box” companies. While this may, prima facie, be revenue positive for NZ, the impact on potential NZ borrowers (including the additional compliance costs) and alternatives needs to be considered.

- 2.22 The creation of a permanent establishment in the payer country can be used to achieve a similar D/NI outcome. For example, a subsidiary company resident in an overseas jurisdiction could borrow from its parent company resident in the same jurisdiction. If the subsidiary allocates the loan to a New Zealand branch, the interest paid on the loan would be treated as deductible in New Zealand (but subject to New Zealand non-resident withholding tax). However, a tax consolidation of the subsidiary with its parent would mean that the interest payment is disregarded in the overseas jurisdiction.

Deductible payments made by a hybrid payer

- 2.23 A simplified arrangement using a hybrid entity to achieve a DD outcome is set out in Figure 2.4.

Figure 2.4: DD arrangement using hybrid entity¹⁹

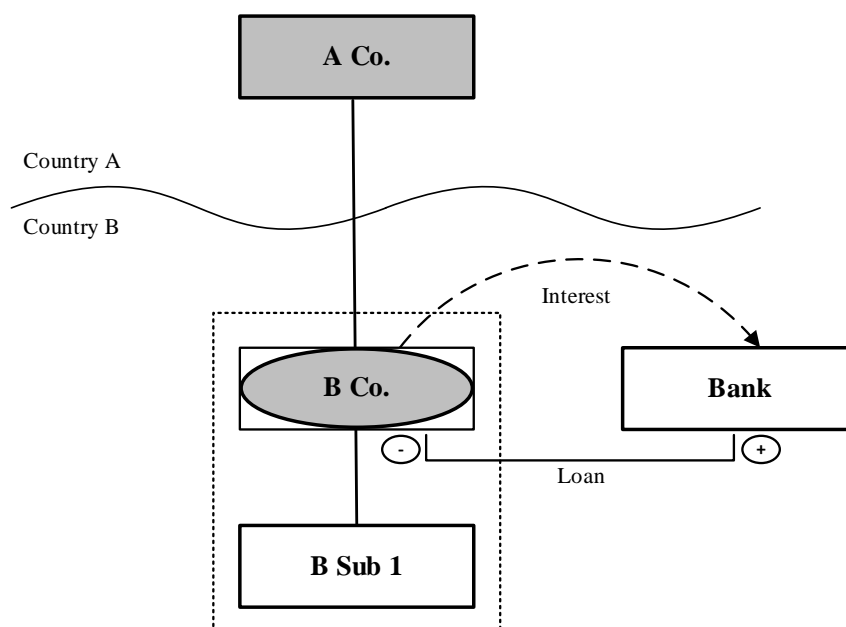

- 2.24 Under the arrangement, A Co (resident in Country A) owns all the shares of B Co (resident in Country B). B Co borrows from the bank and pays interest on the loan, deriving no other income. As Country A treats B Co as transparent, A Co is treated as the borrower by Country A. However, as Country B treats

¹⁹ OECD 2014 Interim Report at p51.

B Co as opaque, B Co is treated as the borrower by Country B. The result is a deduction for the interest expenditure in Country A and B (that is, a DD outcome). If B Co is consolidated for tax purposes with its operating subsidiary B Sub 1, B Co can surrender its tax deduction to B Sub 1, allowing two deductions for the same interest expense to be offset against separate income arising in Country A and Country B.

- 2.25 Australian limited partnerships (treated as transparent in New Zealand, but opaque in Australia) are used to achieve an outbound DD result in essentially the manner described in the example above.²⁰
- 2.26 As with D/Ni, the creation of a permanent establishment in the payer country can be used to achieve a similar DD outcome, if the income and expense of the permanent establishment is eligible to be consolidated or grouped for tax purposes in that country.

Reverse hybrids

- 2.27 A simplified arrangement using a reverse hybrid is set out in Figure 2.5. A reverse hybrid is a hybrid entity that is treated as opaque by its foreign investor, but transparent in the country of its establishment (in the reverse of the examples described above).

Figure 2.5: Payment to a reverse hybrid²¹

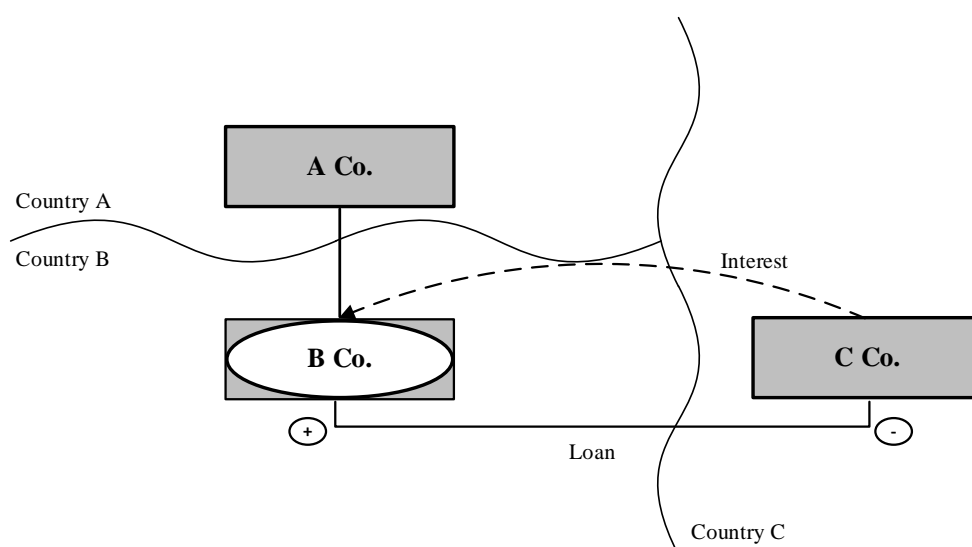

- 2.28 A Co (resident in Country A, the investor country) owns all the shares in B Co, (the reverse hybrid established in Country B, the establishment country). Country B treats B Co as transparent, but Country A treats B Co as opaque. C Co (resident in Country C, the payer country) borrows money from B Co and makes interest payments under the loan. The outcome is D/Ni if the interest

²⁰ The Australian limited partnership (ALP) would have an Australian-resident partner and a New Zealand-resident partner, but the New Zealand-resident partner could hold up to 99.99 percent of the ALP in order to maximise the tax advantage (the DD outcome).

²¹ OECD 2014 Interim Report at p45.

paid by C Co is deductible in the payer country (Country C), but not included as income under the domestic rules of either the investor or establishment country (Country A or B), because each country treats the income as having been derived by a resident of the other country, and Country B does not treat the income as sourced in Country B.

- 2.29 Controlled foreign company (CFC) rules in the investor country that tax the income of residents earned through CFCs on an accrual basis would eliminate such mismatches. However, New Zealand’s CFC rules contain an active income exemption as well as a safe harbour, under which passive income is not subject to accrual taxation if it is less than 5 percent of total income.

KPMG Comment: *This is another example where New Zealand’s tax policy choices are being impacted by the hybrid proposals. NZ’s previous international tax settings generally required accrual income attribution. This was replaced in favour of a tax regime more in line with that of the rest of the world. The decisions at the time contemplated that CFC income would generally not be taxed. We do not believe a global approach will see other countries amending their CFC settings, given the desire to maintain tax competitiveness.*

Indirect outcomes

- 2.30 The effect of a hybrid mismatch that arises between two countries can be imported into another country to create an indirect D/NI outcome, if the first two countries do not have hybrid mismatch rules. An example of this is set out in Figure 2.6.

Figure 2.6: Imported mismatch from hybrid financial instrument²²

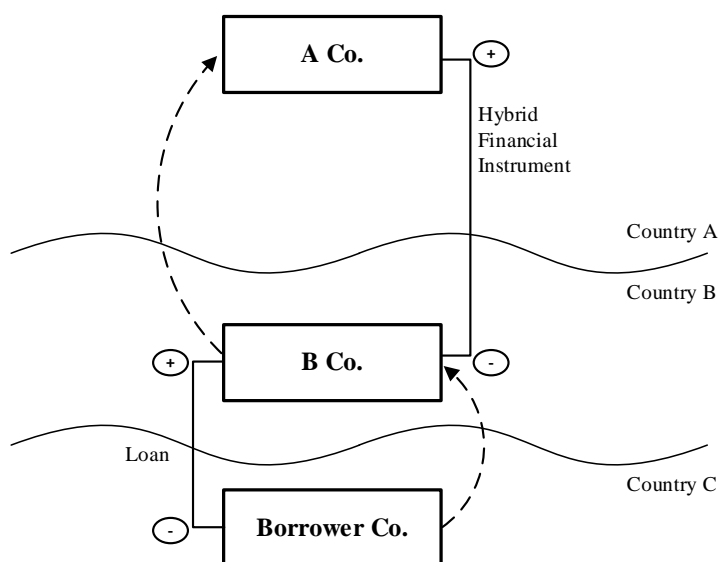

- 2.31 A Co lends money to B Co, a wholly owned subsidiary of A Co, using a hybrid financial instrument, so that payments under the instrument are exempt in Country A, but deductible in Country B. Neither Country A nor Country B has hybrid mismatch rules. Borrower Co then borrows from B Co. Interest

²² OECD 2014 Interim Report at p59.

payable under the loan is deductible in Country C (Borrower Co's country of residence) and taxable income in Country B. The result is an indirect D/NI outcome between Countries A and C (Country B's tax revenue is unaffected as the income and deductions of B Co are offset).

- 2.32 It is difficult for tax investigators to detect imported hybrid mismatches, as detection requires a broad understanding of a taxpayer group's international financing structure. This information is often not publicly available, and can be difficult to obtain from the New Zealand taxpayer. However, if a country were to introduce hybrid mismatch rules without a rule against imported hybrid mismatches that could allow some taxpayers to seek to exploit that gap. This would be against the intended outcome of the rules which is that the tax advantages of hybrid mismatches are neutralised, leading taxpayers to, in most cases, adopt more straightforward cross-border financing instruments and structures.

***KPMG Comment:** It is unclear how much or even why the risk of detection is mentioned at Paragraph 2.32. If there is no such rule, the risk of detection is irrelevant. If there is such a rule, New Zealand applies a self-assessment regime which places the onus on the taxpayer.*

The first two sentences should be discounted in confirming the policy position for New Zealand.

CHAPTER 3

Policy issues

- 3.1 Addressing hybrid mismatches is a key part of the G20/OECD Action Plan (Action Plan) to address base erosion and profit shifting (BEPS). The nature of BEPS means that countries must take a global perspective in tackling BEPS issues, and attempt to reach consensus on a co-ordinated response. In terms of hybrid mismatch arrangements, the double non-taxation result can only arise because of the lack of consistency in the tax treatment of an entity or instrument among countries.
- 3.2 In considering how best to respond to the problem of hybrid mismatch arrangements, the Government is aware that a non-OECD approach could be taken. For instance, some countries are of the view that not implementing the OECD recommendations is in their best interests. Another option is for New Zealand to introduce specific rules targeting the hybrid mismatch arrangements that are known to affect New Zealand.
- 3.3 This chapter discusses the merits for New Zealand of:
- adopting the OECD recommendations
 - introducing a set of targeted anti-hybrid rules and
 - doing nothing in respect of hybrid mismatch arrangements.

Global impact of hybrid mismatch arrangements

- 3.4 The ability of multinational enterprises with access to sophisticated tax advice to take advantage of hybrid mismatch opportunities may provide an unintended competitive advantage over businesses that cannot.²³ The OECD has found some evidence that multinational enterprises with tax planning opportunities tend to have greater market dominance and higher price mark-ups compared with other firms.²⁴
- 3.5 This may lead to welfare losses. For example, the OECD has identified that reduced competition can reduce the need to innovate in order to stay ahead of competitors. Further, differences in the effective tax rate facing multinational enterprises able to exploit mismatches and other firms may also result in a sub-optimal allocation of capital if it means the multinational enterprise crowds out potentially more productive investment by other firms.²⁵

²³ For example, the mismatch may allow the multinational to reduce its prices in the short term with a view to gaining a dominate market share (and then increase prices to increase profits).

²⁴ OECD (2015), *Measuring and Monitoring BEPS, Action 11 – 2015 Final Report*, OECD/G20 Base Erosion and Profit Shifting Project, OECD Publishing, Paris. <http://dx.doi.org/10.1787/9789264241343-en> (Action 11 Final Report) at p169.

²⁵ Action 11 Final Report at p170. The OECD also notes, however, that if tax planning multinational enterprises are more productive than the firms they crowd out, the overall effect on efficiency is unclear.

- 3.6 A related issue is that global resource allocation may be distorted by the availability of hybrid mismatch opportunities. International investment decisions may be made based on whether a mismatch is available rather than fundamental economics.
- 3.7 From a global perspective, hybrid mismatch arrangements typically lead to a reduction of the overall tax paid by the parties involved as a whole. The use of these arrangements has caused a significant drop in worldwide corporate tax revenue, although precisely estimating this loss is a difficult task. Perhaps the best estimate comes from the OECD, which has put the reduction in worldwide corporate tax revenue due to mismatches and preferential tax regimes at between 1.3 and 3 percent (between US\$33 and US\$79 billion in 2014).²⁶
- 3.8 The drop in tax revenues from the use of hybrid mismatch arrangements has real distributional consequences. It means governments must impose higher taxes elsewhere in their economies in order to deliver the desired level of public services. This reduces worldwide welfare. The costs associated with imposing tax generally increase more than proportionately as tax rates increase. Imposing higher taxes elsewhere in order to make up lost tax revenue due to the use of hybrids is likely to be less efficient than imposing more moderate taxes across all economic actors.
- 3.9 Hybrid mismatch opportunities may also contribute to financial instability through increases in tax-leveraged borrowing, or as a result of businesses entering into investments which are uneconomic before tax, but marginally viable after tax as a result of taking advantage of such an opportunity.
- 3.10 Allowing the use of hybrids is also inequitable as it results in uneven tax burdens across different businesses. This is an issue in itself, but may also weaken taxpayer morale. The perception of unfairness that comes from the reported low corporate taxes paid by taxpayers who can take advantage of hybrid mismatch opportunities (and/or employ other BEPS strategies) is an issue. This perception of unfairness undermines public confidence in the tax system and therefore the willingness of taxpayers to voluntarily comply with their own tax obligations.
- 3.11 The OECD's recommendations represent an agreement by participating countries that hybrid mismatch arrangements should be neutralised and also how they should be neutralised. While tolerating mismatches in some cases may have benefits to one country (at the expense of another), that behaviour carries a range of negative consequences. It harms competition, reduces worldwide revenue collection in an arbitrary and unintended way, results in inefficient investment decisions and damages the public's perception of the "fairness" of the tax system.

²⁶ Action 11 Final Report at p168. The method adopted by the OECD means that losses due to hybrids and preferential regimes cannot be disentangled.

KPMG Comment:

Action 11 Evidence

This section relies on the OECD's Action 11 October 2015 final report. That report is itself hedged on the economic impacts. The second summary of Chapter 1 states:

“This chapter concludes that the significant limitations of existing data sources mean that, at present, attempts to construct indicators of or undertake an economic analysis of the scale and impact of BEPS are severely constrained and as such should be heavily qualified.” (at p17)

In our view, this means that the economic and revenue effects of BEPS stated in these paragraphs should be, at best, weak evidence for the policy position being asserted in the document.

Market dominance

We note it is not clear whether tax planning opportunities create market dominance or can be used because of market dominance. To use UK examples, boycotts of Starbucks have not been matched for calls of boycotts for products and services of other companies. For a New Zealand example of the same point see [link](#).

Strength of conclusions

We note the use of the conditional “may” in paragraphs 3.5, 3.6 and 3.9 of the document.

Hybrid results are or will become preferential regimes

We note the estimate of revenue loss is for hybrids **and** preferential regimes. In our view, the distinction between a hybrid effect and a preferential regime as used by the OECD is arbitrary. In our view, at some point, a hybrid result will become a preferential regime.

A country that does not originally tax an amount (based on whatever policy determinations it considers appropriate) will become aware the regime produces a double non-taxation result. If it does not change that result the regime becomes preferential (because by definition it is an acceptable and deliberate outcome).

We have not analysed the position in detail but it appears that the USA's hybrid results may be an example. The USA appears to continue to support such results because the WTO rules allow such tax policy approaches when they would prevent direct subsidies for exporting. A recent example of USA's concerns, albeit for VATs, can be found [here](#).

As we understand it, this Bill proposes a tariff on goods imported to the USA from countries with a VAT where input tax is allowed. This is

said to be an unfair subsidy. Although it appears to mis-understand the nature of a VAT, it illustrates the desire of the USA to encourage its exporters.

Importance of perceptions of fairness and integrity and their correctness

We **absolutely** acknowledge that perceptions of fairness and integrity of the tax system are important to the analysis of the hybrids recommendations. As this is the most concrete evidence (apart from “other countries are doing it as well”) in support of the proposals it deserves more attention and consideration than it is given.

In our view, the two main drivers of this perception are:

- a sale made to a country should be taxed there; and
- income tax is borne by the company and it should be made to pay it.

In the current environment, an expert view seems to be discounted but we would expect both Government and Officials to be cognisant of the nuances of both positions.

Source of sales income and the right to tax

The international consensus preceding the BEPS project has been that sales made **in** a country can be taxed while sales **to** a country are outside the country’s tax base. That is and has been New Zealand’s position as well. The modern economy has raised fundamental questions of whether that should remain the case. Other BEPS actions seek to re-draw the border and are doing most of the work to re-align the international consensus.

Our view is that the BEPS work broadens the concept of sales **in** a country. It still does not extend to give taxing rights to sales **to** a country.

Who bears the tax?

There is a significant literature on who bears the corporate income tax. Is it labour (i.e. workers and consumers) or capital? New Zealand’s historical position has been that it is labour that bears New Zealand’s income tax on inbound direct investment. Higher taxes means either higher costs for consumers, or lower returns for labour, or both. Lower taxes, other things being equal, benefit both.

The hybrid proposals instead rest on the assumption that the cost of the corporate income tax rests largely on direct capital and its foreign owners. There is, in our, view some justification for that position. Declared and recorded tax expenses can be expected to have an effect on the value of a multinational and therefore on the value of shareholders’ interests in the company.

However, additional taxes may also have an effect on domestic consumers and labour. This is more difficult to see in the modern economy. Consumers do not see such effects as they receive many services “free”. For example, no consumer in New Zealand is charged for a Google search. The search is “paid for” by advertising bought by companies. The cost is included in the charge for the products and services bought by the consumer. Such an indirect effect is not obvious. An increase in the charge may not therefore be material for a consumer.

We see nothing in the document which constitutes a rational analysis of the perception and whether, and to what extent, it should influence policy making. For example, an assessment of the correctness of the views may suggest the alternative is to provide better information on New Zealand’s tax regimes and the underlying tax policy settings (and why they were chosen) to the wider community.

True source of income from equity and existing proxy allocations

Related to both views is the appropriate allocation of taxing rights for income from capital. Traditionally, full taxing rights are allocated to where capital is used. This treats equity capital income as sourced only where such capital is used.

However, where the capital is in the form of debt, both the country of source of the income (where the funds are used) and the country which provides the debt capital are entitled to tax the income. The country of source generally taxes the income at a lower rate by applying a withholding tax.

In our view, these rules, together with thin capitalisation rules for inbound foreign investment provide a proxy for the allocation of income from capital. This acknowledges that a foreign direct investor can employ debt or equity or a mixture of the two.

New Zealand’s domestic law therefore already provides a boundary for taxing income which is considered to be “truly” income sourced in New Zealand.

A hybrid result should not fundamentally change that principled answer. It does not mean that income has not been appropriately allocated to New Zealand. New Zealand has already made that choice.

The case is simply that more tax will be raised at no cost?

Instead, what a hybrid result does is raise the question of whether there is an opportunity to increase the New Zealand tax take without raising the cost to the New Zealand economy. We understand that Officials may have answered this in the affirmative – there is no loss if

the amount would otherwise be taxed. (However, this is at best implied in the document.)

It is not obvious that this result has been well thought through. This is particularly the case as we understand that Australia is seen as the major source of hybrid mis-matches. Australia's franking regime, like New Zealand's imputation regime, creates a preference for domestic rather than foreign taxes. We would therefore expect a marginal loss for Australian investors from imposing greater New Zealand income tax. The decisions are therefore not costless.

The case for implementation is yet to be strongly made

For these reasons, we consider the document does not make the case for the OECD recommendations or at least for their "blanket" implementation in a strongly founded way. This makes it important to consider the specific recommendations carefully.

Uptake in other countries

- 3.12 The Australian Government asked the Australian Board of Taxation to consult on implementation of the OECD recommendations in 2015.²⁷ The Board released a discussion paper regarding implementation, inviting written submissions, on 20 November 2015,²⁸ and reported to the Australian Government in March 2016.²⁹ The Australian Government then committed to implementing the OECD's recommendations on hybrid mismatch arrangements anti-hybrid rules as part of its Budget 2016–17.³⁰ The Board has further been tasked with examining how best to implement the OECD recommendations in respect of hybrid regulatory capital and is due to report back by the end of July 2016.
- 3.13 The Government of the United Kingdom has already consulted on adopting the OECD's approach to addressing hybrid mismatches,³¹ and has now introduced legislation to Parliament (see Schedule 10 of the Finance (No.2) Bill). The intention is that the legislation will have effect from 1 January 2017.³²
- 3.14 The Council of the European Union adopted the Anti-Tax Avoidance Directive in June 2016, which sets out six anti-avoidance measures that all EU member states must implement into their own tax systems by 31 December 2018. One of the six anti-avoidance measures is to implement rules to counteract intra-

²⁷ The terms of reference for this project can be found at

<http://taxboard.gov.au/consultation/implementation-of-anti-hybrid-rules/>

²⁸ Board of Taxation, Implementation of the OECD anti-hybrid rules (2015).

<http://taxboard.gov.au/files/2015/08/BoT-Anti-hybrid-Discussion-Paper.pdf>

²⁹ This report was subsequently released to the public on 3 May 2016.

<http://taxboard.gov.au/files/2016/05/Implementation-of-the-OECD-hybrid-mismatch-rules.pdf>

³⁰ 2016–17 Budget Paper No 2 – Revenue Measures p34.

³¹ HM Treasury and HM Revenue & Customs, *Tackling aggressive tax planning: implementing the agreed G20-OECD approach for addressing hybrid mismatch arrangements* (December 2014).

³² Refer to s 22 of the Schedule to Clause 33 (Hybrid and Other Mismatches) of the Finance Bill 2016 (United Kingdom).

EU hybrid mismatch arrangements.³³ The European Council, with reference to the OECD recommendations, has also asked the European Commission to propose rules by October 2016 that apply to hybrid mismatch arrangements involving non-EU countries.

- 3.15 Some countries have introduced domestic rules to combat the effects of hybrid mismatch arrangements prior to the OECD BEPS project or without explicitly following the OECD recommendations. These countries include Denmark, France, Spain, Mexico and Austria, while Germany and Hungary have proposed to introduce rules in the future.

KPMG Comment: See our earlier comments.

Australia's proposals may make New Zealand's proposals redundant for the majority of New Zealand's mis-matches. In other words, the ability for New Zealand to increase its tax take without cost may be limited but significant compliance costs and complexity will be introduced. This will not be welfare enhancing for New Zealand.

Given that outcome, New Zealand may be able to take a more targeted and limited approach to its own implementation of the OECD's recommendations.

This could be viewed as "opportunistic". However, we simply mean a better understanding of what the global landscape will look like prior to final decisions will lead to better outcomes for New Zealand. Those areas that need to be dealt with can be, others with no or little benefit can be deferred or not pursued at all.

In any case, other countries can be expected to take a national welfare approach to their tax policy settings; New Zealand should be no different.

At a minimum, consideration should be given to the interaction of Australia's proposals (once the detail of those proposals is clear) with New Zealand's to see whether that should produce a different recommendation for New Zealand.

Impact of hybrid mismatch arrangements on New Zealand

- 3.16 New Zealand has a general anti-avoidance rule (GAAR) that can, in some instances, neutralise the tax effects of a hybrid mismatch arrangement (such as the arrangement in *Alesco*). However, the target of the GAAR is arrangements that avoid New Zealand tax. The arrangement must also do so in a manner that is outside Parliament's contemplation; a classic indicator being that the arrangement gains the advantage in an artificial or contrived way.³⁴ Although the use of a hybrid mismatch arrangement reduces the overall tax paid by the parties to the arrangement, it is often difficult to determine which country

³³ Article 9 of Council Directive FISC 104 ECOFIN 628, 17 June 2016.

³⁴ *Ben Nevis Forestry Ventures Ltd v Commissioner of Inland Revenue* [2008] NZSSC 115, [2009] 2 NZLR 289 (SC).

involved has lost tax revenue. Further, the use of a hybrid is not necessarily artificial or contrived in and of itself. Accordingly, the GAAR does not provide a comprehensive solution to counter the use of hybrid mismatch arrangements. This is also seen in Australia where the “black letter” tax treatment of the hybrid instruments in the *Mills* case referred to above was not reversed by the equivalent Australian anti-avoidance provision, on the basis that the tax benefit was incidental to the commercial benefit.

KPMG Comment: *The acknowledgement that the use of a hybrid arrangement is not necessarily artificial or contrived raises a significant issue. The use of “exploits” in the OECD definition implies an unintended effect. The breadth of the rules and even the examples used suggest that commercial arrangements will be affected by the proposals.*

Countering the hybrid results means that commercial arrangements will be influenced by the tax outcomes. A commercial choice will be limited by a perception that the intended domestic outcomes are inappropriate.

The hybrid proposals should not affect legitimate commercial choices (in a New Zealand context, this includes those allowed under other New Zealand tax regimes, such as the FIF rules).

- 3.17 The New Zealand tax revenue loss caused by the use of hybrids is difficult to estimate because the full extent of hybrid mismatch arrangements involving New Zealand is unknown. However, the tax revenue at stake is significant in the cases that the Government is aware of, which shows a clear advantage to counteracting hybrid mismatch arrangements. For example, the amount at issue under all funding arrangements comparable to the *Alesco* arrangement referred to in Chapter 2 was approximately \$300 million (across multiple years).

KPMG Comment: *Given the result in Alesco, this amount of revenue is clearly not at stake. We assume that the Government does not mean to imply that Alesco was incorrectly decided.*

We further note, as above, that this is likely to significantly over-state the position. It assumes that equity instruments are the appropriate counter-factual rather than vanilla debt. A simple debt instrument is likely to give equivalent (or potentially higher) tax deductions in New Zealand. The revenue benefit will be offshore.

The same comments may apply to the next quoted revenue loss but this is not clear as the examples and calculations are not disclosed.

Further, in neither case, is there an assessment of the national welfare impact. The unanswered question is whether these amounts were invested in New Zealand?

In relation to hybrid entities, deductions claimed in New Zealand that are attributable to some prominent hybrid entity structures result in approximately \$80 million less tax revenue for New Zealand per year.

- 3.18 However, it is possible that a particular hybrid mismatch will be to New Zealand's benefit (and to another country's detriment). If an arrangement results in the elimination of residence-country taxation, the return to the investor will increase while New Zealand will continue to earn the same level of tax revenue. The investor will have incentives to increase their investment in New Zealand.
- 3.19 On the other hand, a hybrid mismatch may also result in the elimination of tax in New Zealand. If the availability of the hybrid means the investor invests using the hybrid instead of equity – or crowds out investment by another investor who would have invested through equity – the result is a clear welfare loss for New Zealand. Tax revenues would fall and actual investment in New Zealand would remain unchanged.

KPMG Comment: The discussion does not make obvious the downstream effects of the "crowding out" of investment. It appears to assume a finite level of investment in New Zealand. The crowded out investment and the alternative investor will make other investments. Those downstream effects do not appear to have been factored into the analysis.

- 3.20 Importantly, it is generally impossible to tell which of these situations will arise: whether a hybrid mismatch will result in the elimination of residence-country tax or the elimination of New Zealand tax. More broadly, even if it could be shown that New Zealand would be the beneficiary of a hybrid mismatch, it is an open question whether allowing the mismatch to be exploited would be appropriate. The double non-taxation benefits that arise from exploiting hybrid mismatches are (except in very unusual cases) not intended by either country.

KPMG Comment: The evidence would suggest that the comment about double non-taxation benefits not being intended is a mis-statement. There are public and obvious examples of hybrid results which have not been countered.

The Government appears to be substituting the judgement of foreign revenue officials for the judgement of foreign Governments and parliaments for what is and is not intended.

New Zealand would obviously welcome an intentional foreign policy that makes it more attractive for non-residents to invest here.

KPMG Comment: There are obvious examples of tax policies of foreign countries which do make it attractive to invest in New Zealand. These appear to be ignored by the document. These would include foreign regimes which do not tax foreign income either earned directly (e.g. territorial tax systems) or through certain entities (e.g. by CFCs), which do not tax certain domestic entities (for example, pension funds or charities) even if they invest offshore, or which do not tax equity income if a deduction is available in the source jurisdiction.

A further obvious example is of a country which does not implement the hybrid recommendations. Any future hybrid results should be considered to be intended.

Allowing the exploitation of unintended mismatches in tax rules to achieve non-taxation of income is another matter.

- 3.21 The use of hybrid mismatches can result in losses to New Zealand in other ways as well. For example, hybrids have been an important feature of tax avoidance arrangements in recent history. A simple example using a hybrid financial instrument is illustrated in Figure 3.1 below.

Figure 3.1: Pure economic loss

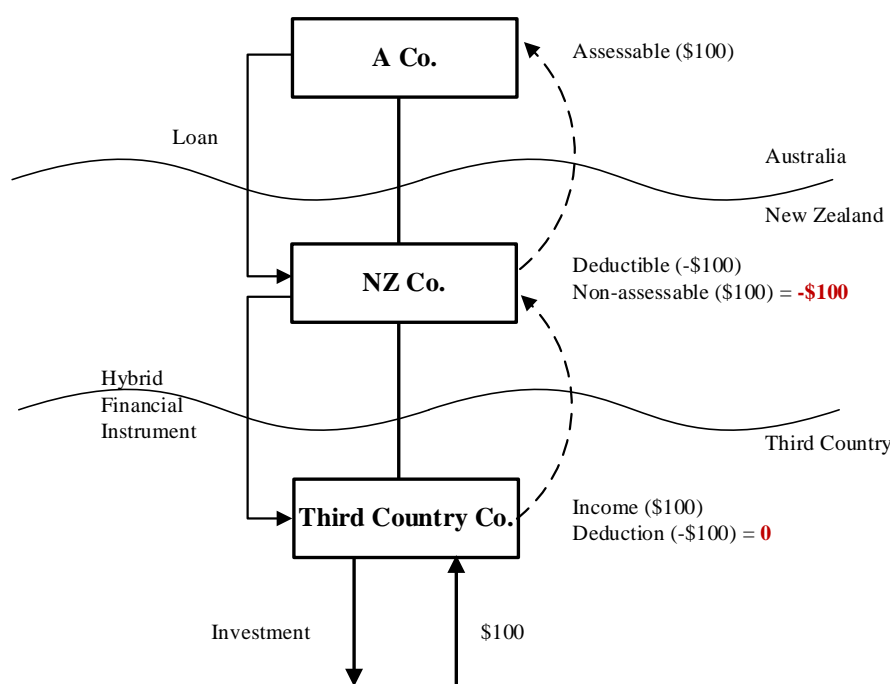

- 3.22 Prior to the arrangement, A Co (resident in Australia) invests into a subsidiary, Third Country Co (resident in a third country) by way of a loan. Interest payable under the loan is deductible to Third Country Co under the third country's domestic rules, and taxable to A Co under Australia's domestic rules. However, A Co also has a subsidiary resident in New Zealand, NZ Co, paying New Zealand tax. Under the arrangement, A Co instead lends to Third Country Co through NZ Co, using a hybrid financial instrument on the New Zealand/third country leg. As a result, the group can obtain an additional deduction for its financing cost. The outcome is a pure economic loss to New Zealand – a reduction in New Zealand tax with no change in economic activity.

- 3.23 As other countries adopt the OECD recommendations, the case for New Zealand to also adopt the recommendations is strengthened. This is because, depending on how taxpayers react to the rules, a hybrid mismatch arrangement involving a New Zealand counterparty may still be countered (thus eliminating the benefit of the use of the hybrid to New Zealand, if there is one), but the tax collected would be by the counterparty country, rather than New Zealand due to the primary/defensive rule structure of the OECD recommendations. In

particular, there would likely be scenarios where Australia and the United Kingdom (who are both key sources of inbound and outbound investment for New Zealand) would counteract a hybrid mismatch arrangement involving New Zealand and collect all of the resulting revenue. These scenarios provide an incentive for New Zealand to follow Australia and the United Kingdom in adopting the OECD recommendations.

KPMG Comment: *Paragraph 3.23 does not make sense. It follows a paragraph which says that New Zealand has an economic loss by allowing a deduction with no corresponding change in economic activity. If New Zealand introduces hybrid rules, it would presumably not allow a deduction so it would also have an increase in tax? Is the counter-factual that New Zealand will no longer be used to fund the third country and the tax will be collected by Country A? In that case, New Zealand still collects the tax because it does not provide a deduction?*

3.24 Further, hybrid mismatch arrangements involving New Zealand and other countries that do not adopt the OECD recommendations will be left unresolved unless New Zealand adopts the OECD recommendations.

3.25 However, instead of adopting the OECD recommendations in their entirety, New Zealand also has the option of introducing rules that specifically target the known hybrid mismatch arrangements affecting New Zealand, such as ALPs and MCNs. This approach may reduce complexity, as fewer rules would be needed (at least initially) in comparison to a full adoption of the OECD recommendations. However, it would be difficult to precisely identify the rules that would be needed and the rules that would not.

KPMG Comment: *We consider that the difficulty is overstated. In any case, focusing on particular recommendations may allow appropriate early targeting of hybrid results which should be countered. This would allow time for fuller consideration of other issues identified in the document.*

Also, it is likely that taxpayers would respond to targeted rules by exploiting other tax planning opportunities left open by this approach. The Government is therefore of the view that adopting the comprehensive set of OECD recommendations at the onset is a proactive, and likely cleaner option. Adopting the recommendations in full also has the advantage of being consistent with the intended approach of Australia and the United Kingdom.

KPMG Comment: *It does not however appear to be consistent with the current position of the USA (which we believe is unlikely to change)? What if any effect should this have on New Zealand's tax policy decision making?*

3.26 The Government's desire is that any new rules addressing hybrid mismatch arrangements should be effective from a policy perspective, but be as simple as possible to comply with and administer. In considering the need for simplicity, the Government will take into account the fact that in most cases,

the impact of hybrid mismatch rules will be to encourage businesses to use simpler structures which do not require the rules to be applied.

KPMG Comment: *The detailed proposals do not appear to take into account this principle of simplicity of compliance. We appreciate that there is an inter-connectedness – i.e. is there a hybrid problem and how simple is the countering measure – of the questions to be answered. In a number of cases, our view that there is no hybrid problem is supported by the complexity of the compliance and the commerciality of the arrangement.*

- 3.27 Taking the discussed factors and arguments into account, the best approach for New Zealand is likely to be to co-operate with other countries to eliminate hybrid mismatches by adopting the OECD recommendations. As noted above, when companies exploit hybrid mismatches, the result is that no tax is paid anywhere on a portion of income.

KPMG Comment: *See our earlier comments on the use of “exploit” in the document. This is inconsistent with descriptions of some hybrid results having commercial effects.*

This leads to an inefficient allocation of investment as cross-border investments where mismatches are available are subsidised relative to other investments. Eliminating this misallocation would increase worldwide efficiency, leading to higher worldwide incomes – which New Zealand will likely share in.

KPMG Comment: *The reference to NZ “likely” sharing in any benefit from increased allocative efficiency of investment decisions confirms our view that the benefit to New Zealand is founded on weak evidence and analysis. New Zealand should therefore proceed with caution and care.*

CHAPTER 4

OECD recommendations

- 4.1 The OECD's recommended domestic rules under Action 2 aim to eliminate the tax benefit of using a hybrid mismatch arrangement.
- 4.2 The most effective way to do this would be to harmonise the tax rules of the countries concerned. If, for example, all countries had the same rules for distinguishing debt from equity, the opportunity to arbitrage the debt/equity distinction would no longer arise. However, as harmonisation does not seem possible even for the most commonly exploited differences in tax treatment of instruments and entities, this approach is only theoretical.

KPMG Comment: This is consistent with our view that the OECD recommendations are pragmatic, rather than principled.

The document does not answer the question of why harmonisation is not possible. The answers may include:

- Countries are comfortable with the boundaries drawn by their domestic legislation. The hybrid effects are therefore intended;*
- The domestic results produce non-tax results which are deliberately sought by those countries;*
- Not all countries have sufficient policy resource to properly consider and promote good tax policy so that domestic rules reflect good tax policy.*

To the extent that hybrid rules increase income for the other country and not New Zealand, it is only the third answer which justifies New Zealand protecting other countries from themselves.

We acknowledge that care needs to be taken on assumptions of other countries' and revenue authorities' capabilities (or lack thereof). Further, "good tax policy" will be in the eye of the beholder. What is good in the New Zealand context may not necessarily be good in other countries. This is particularly so if tax policy is used as a lever for other public policy objectives. Divergences in view will need to be accommodated.

This suggests that New Zealand should consider the hybrid results for their effect on New Zealand only. The focus should be on whether New Zealand, as opposed to global welfare, is maximised by implementing the hybrid rules. This does not discount the benefit of a global response. That remains a relevant factor but should not be a sole factor.

- 4.3 Instead, the OECD has recommended domestic rules that consist of:
- specific improvements to domestic rules designed to achieve a better alignment between those rules and their intended tax policy outcomes (specific recommendations); and

- rules that neutralise the tax outcomes of a hybrid mismatch by linking the tax outcomes of a payment made by an entity or under an instrument to the tax outcomes in the counterparty country (hybrid mismatch rules).

4.4 There is an expectation that the OECD’s recommended rules be used as a template for reform. By doing so, a consistent approach to addressing hybrid mismatches will be applied across countries. Consistent rules that are consistently applied across countries will best ensure that the rules are effective at eliminating double non-taxation, while minimising the risk of double taxation and compliance and administrative costs for both taxpayers and administrators.

KPMG Comment: In our view, the recommendations do not pay sufficient attention to the potential for resulting double taxation. This may be because the expectation is that alternative arrangements will be entered into. This ignores the commercial effects of the hybrid arrangements.

Further, in our view, the choices made to not limit the application of a rule are stated to be to reduce administration and compliance costs in preference to eliminating double taxation. This may be influenced by countries which have revenue authority assessment rather than self-assessment regimes. New Zealand’s self-assessment regime means that such costs should have a lesser influence than double taxation.

However, the proposed hybrid mismatch rules are designed so that the effects of a hybrid mismatch will be neutralised, even if the counterparty country has not adopted such rules.

4.5 This document proposes that New Zealand introduces domestic rules that are largely in line with the OECD recommendations, with only minor adjustments of those recommendations to ensure that they make sense in terms of New Zealand’s other domestic rules and international tax framework. Final policy decisions will only be made on the outcome of consultation with the businesses that will have to apply any new rules.

Hybrid mismatch rules – OECD recommendations

4.6 The OECD recommendations include a series of “linking rules” which adjust the tax treatment of a hybrid mismatch arrangement in one country by reference to the tax treatment in the counterparty country, without disturbing any of the other tax, commercial or regulatory consequences.

4.7 The target of the rules is D/Ni, DD and indirect D/Ni mismatches that arise from payments. The OECD considers that rules that, for example, entitle a taxpayer to “deemed” interest deductions for equity capital, are economically more akin to a tax exemption, so do not produce a mismatch in the sense targeted.³⁵ The recommended rules are not generally intended to pick up mismatches that result from differences in the value ascribed to a payment.

³⁵ 2015 Hybrids Report at para 28.

For example, a mismatch in tax outcomes as a result of foreign currency fluctuations on a loan,³⁶ or differences due solely to timing. They do apply to deductions which, although attributable to payments, are not for the payments themselves, such as interest calculated under the financial arrangement rules.

KPMG Comment: the deemed interest deduction example at Paragraph 4.7 not producing a hybrid mismatch is symptomatic of the inconsistency underlying the recommendations. What may be a deliberate design feature of one country's tax system (i.e. a tax exemption) may be (mistakenly or otherwise) considered by another country as giving rise to a hybrid result. The result will inevitably be inconsistent rules, and outcomes, across jurisdictions.

- 4.8 While cross-border mismatches arise in other contexts (for example, the payment of deductible interest to a tax-exempt entity, or the sale of an asset from a capital account holder to a trader), the mismatches targeted are only those that rely on a hybrid element to produce the outcome.³⁷
- 4.9 The OECD recommended rules are organised into a hierarchy, which takes the form of a primary rule and a secondary, defensive, rule. This hierarchy approach means that double taxation is avoided because the defensive rule only applies when there is no hybrid mismatch rule or the rule is not applied in the counterparty country. It also means that the effects of a hybrid mismatch are neutralised by the operation of the defensive rule even if the counterparty country does not have effective hybrid mismatch rules.
- 4.10 If New Zealand follows the approach adopted in the UK legislation, it is likely that these linking rules would form a separate subpart in the Income Tax Act.

KPMG Comment: Our comments on the above paragraphs and those below are generally in the relevant chapters that follow.

We note the importance of a clear set of rules which establish the priority of "ordinary" domestic rules, the new subpart and the application of the General Anti-Avoidance Rule (GAAR).

Recommendation 1: Hybrid financial instrument rule

- 4.11 The hybrid financial instrument rule applies to payments under a financial instrument that can be expected to result in a hybrid mismatch (that is, a D/NI result). A financial instrument can be either a financial arrangement or an equity instrument. The primary rule is for the payer country to neutralise the mismatch by denying the deduction. If it does not, the payee country should tax the payment. Countries only need to apply this rule to payments under financial instruments as characterised under their own domestic law. So, for example, a cross-border lease payment by a resident under an operating lease is not subject to this rule, even if the lessor country treats the lease as a finance lease.

³⁶ 2015 Hybrids Report at para 54.

³⁷ 2015 Hybrids Report at paras 91–98.

- 4.12 The rule also applies to substitute payments, which are payments under a transfer of a financial instrument which in effect undermine the integrity of the rules. This will be the case if the transfer and substitute payment secure a better tax outcome than if the transfer had not taken place.³⁸
- 4.13 The reason for dealing with the deduction first is that it will generally be apparent that a deduction for a payment is being claimed in a country, and then it is possible to determine whether that payment is included in income in the payee country. However, it may not be as straightforward to identify the non-inclusion of a payment in income.
- 4.14 This rule only applies to payments between related parties (broadly, 25 percent or more common ownership) or under structured arrangements. A structured arrangement is defined in Recommendation 10. In broad terms it is an arrangement that is designed to produce a hybrid mismatch. These limitations are designed so that the rules apply in situations when the parties are able to obtain information about, or should be aware of, the tax treatment of the payment to the counterparty.

Recommendation 2: Specific recommendation for the tax treatment of financial instruments

- 4.15 The OECD's recommendations for specific improvements to domestic rules for taxing financial instruments are rules that:³⁹
- deny a dividend exemption (or equivalent relief from economic double taxation) for deductible payments made under financial instruments;
 - prevent hybrid transfers being used to duplicate foreign tax credits for taxes withheld at source, by limiting the amount of a credit to the amount of tax on the net income. A hybrid transfer is a transfer of a financial instrument where differences in two country's tax rules mean each treats the financial instrument as held by a resident.
- 4.16 This recommendation has no limitation of scope (for example, it is not limited to related parties or structured arrangements).

Recommendation 3: Disregarded hybrid payments rule

- 4.17 The third recommendation is to neutralise mismatches arising from payments (whether or not in relation to a financial instrument) by hybrid payers.
- The payer country should deny a deduction for a payment that gives rise to a D/NI outcome.
 - If it does not do so, the amount should be included in income in the payee country.

³⁸ 2015 Hybrids Report at para 79.

³⁹ 2015 Hybrids Report at para 5.

- No mismatch will arise to the extent that the deduction in the payer country is offset against income that is included in taxable income in both the payee and payer country (dual inclusion income).
- Disallowed deductions can be carried forward and offset against dual inclusion income in future years.

So, for example, if a hybrid entity makes a deductible payment to its foreign parent, and that payment is disregarded in the parent country because it treats the hybrid entity as a part of the parent, then *prima facie* the country where the hybrid is resident should deny a deduction for the payment. If it does not, the parent country should tax the payment. Neither response is required if the hybrid entity in the same year derives an equal amount of income which is taxed in both countries (that is, is dual inclusion income).

4.18 This rule applies only to payments between members of the same control group, or parties to a structured arrangement. Entities are in the same control group if they are consolidated for accounting purposes, if they are commonly controlled, if they are 50 percent or more commonly owned, or if they are associated under Article 9 of the OECD Model Treaty.

Recommendation 4: Reverse hybrid rule

4.19 Recommendation 4 applies to any deductible payment made to a reverse hybrid which results in a hybrid mismatch. A hybrid mismatch arises if the payment is not taxable to the reverse hybrid in either its establishment country or the residence country of an owner, but would have been taxable if paid directly to the owner. *Prima facie* an interest payment made to a New Zealand zero-rate PIE in respect of the interest of a foreign investor in the PIE might well be subject to this rule (though it would be out of scope unless there were a structured arrangement). The rule is for the payer to be denied a deduction.

4.20 The rule applies where the payer, the reverse hybrid and its owner are in the same control group, and to a payment under a structured arrangement to which the payer is a party.

Recommendation 5: Specific recommendation for reverse hybrids

4.21 Recommendation 5 contains 3 specific recommendations for domestic rules relating to reverse hybrids. These are to:

- improve controlled foreign company (CFC) and other offshore investment rules to ensure the taxation of the income of hybrid entities in the investor country
- restrict the tax transparency of reverse hybrids that are members of a control group,; and
- encourage countries to adopt appropriate information reporting and filing requirements for transparent entities established in their country (for example, in the case of New Zealand, partnerships, trusts and PIEs).

Recommendation 6: Deductible hybrid payments rule

- 4.22 Recommendation 6 applies to payments by a hybrid payer who makes a payment that is deductible under the laws of both the payer country and the country of the owner, if the payment results in a hybrid mismatch. The owner country should deny the deduction, and if it does not, the payer country should do so. A payment will only give rise to a hybrid mismatch if it is deducted against income which is not dual inclusion income. Disallowed expenditure can be carried forward and offset against dual inclusion income in future periods.
- 4.23 A person will be a hybrid payer if they are entitled to a deduction for a payment in a country where they are not resident, and either they or a related person is also allowed a deduction for that payment in the residence country. They will also be a hybrid payer if they are entitled to a deduction for a payment in their residence country and the payment triggers a second deduction for an investor in the payer in another country.
- 4.24 There is no scope limitation on the primary rule. Disallowance in the payer country (the secondary rule) only applies if the parties are in the same control group or when the person is party to a structured arrangement.
- 4.25 In addition, the Final Report suggests countries may wish to apply this rule to deductions that are not directly attributable to payments, for example, depreciation.⁴⁰

Recommendation 7: Dual-resident payer rule

- 4.26 Recommendation 7 applies to payments by a dual resident payer. If the payment is deductible in both countries, both should deny a deduction to the extent that it is offset against income which is not taxable in both countries.
- 4.27 As with Recommendation 6, Recommendation 7 includes an ability to carry forward any unused deductions and set them off against future dual inclusion income. Losses can also be used in one country if they have become unusable in the other (stranded losses). There is no limitation on the scope of this rule.

Recommendation 8: Imported mismatch rule

- 4.28 To expand the coverage of the rules, Recommendation 8 requires a payer country to deny a deduction for an imported mismatch payment to the extent the rules treat the payment as offset against a hybrid deduction in the payee country. This means that the rules can require disallowance even when the payee is returning the amount received as income, if there is the necessary degree of connection between the payee's receipt of the payment, and the payee making a payment under a hybrid mismatch arrangement.

⁴⁰ OECD 2015 Final Report at para 192.

- 4.29 This rule is proposed to apply only if the payer is in the same control group as the parties to the mismatch arrangement, or when the payer is party to a structured arrangement.

Recommendation 9: Design principles

- 4.30 Recommendation 9 sets out the design principles for the OECD rules, and also their implementation and co-ordination at a domestic level. These are considered in more detail in Chapter 11.

Recommendations 10 – 12: Definitions

- 4.31 Recommendations 10–12 deal with definitions, including in particular, the definition of a structured arrangement, related persons, control groups and acting together.

Double tax agreement commentary

- 4.32 Chapters 13 and 14 of the Final Report intend to ensure that, through modifications to the OECD Model Tax Convention and its Commentary,⁴¹ the benefits of double tax agreements (DTAs) are not inappropriately accessed through the use of hybrid instruments and entities:

- Chapter 13 provides commentary on a proposed change to Article 4(3) of the OECD Model Tax Convention whereby issues of an entity's dual residence can be resolved by the competent authorities of each DTA partner rather than through the application of an interpretative rule as to the place of effective management. The chapter also suggests a domestic law change deeming an entity not to be a resident of a state if that entity is considered to be resident of another state due to the operation of a DTA.
- Chapter 14 provides commentary on the proposed introduction of Article 1(2) to the OECD Model Tax Convention which deals with the treatment of (wholly or partly) fiscally transparent entities.

- 4.33 Where possible, the suggested changes will be incorporated into New Zealand's DTA network through the OECD's work on Action 15 of the BEPS Action Plan (Developing a Multilateral Instrument to Modify Bilateral Tax Treaties), and through bilateral DTA negotiations.

- 4.34 Chapter 15 of the Final Report provides commentary on any potential conflict in the interaction of tax treaties and the OECD's domestic law recommendations. The Government does not foresee any potential conflict between the recommendations and New Zealand's DTA network. However, readers are welcome to submit on that point.

⁴¹ OECD (2014), Model Tax Convention on Income and on Capital: Condensed Version 2014, OECD Publishing, http://dx.doi.org/10.1787/mtc_cond-2014-en

- 4.35 The DTA commentary will not be considered in Part II of this document as there is no domestic law reform that could be taken in this area (although the dual resident entity domestic law suggestion noted above is discussed in more detail in Chapter 9).

Submissions on Part I

- 4.36 Specific calls for submission are set out in Part II of the document. However, the Government is also open to submissions on any aspects of Part I of the document. Submissions should include a brief summary of major points and recommendations and should refer to the document's labelled submission points where applicable.

KPMG Comment: To reiterate our comments above, in our view, the benefit to New Zealand of adopting comprehensive hybrid rules is founded on weak evidence and analysis. New Zealand should proceed with caution and care. It should focus on direct New Zealand results and domestic outcomes to consider their appropriateness.

PART II

Details of OECD recommendations

KPMG Comment: As a general comment, we note that it would be easier to follow the arguments if the examples used labelled the New Zealand entity. The application of the current New Zealand rules and the proposed hybrid rules would be clearer. As a result, identifying whether there is a problem or not would also be clearer.

CHAPTER 5

Hybrid financial instruments

- 5.1 This chapter discusses and asks for submissions on, various aspects of implementing the first two recommendations in the OECD's Final Report. It first considers changes to existing domestic rules (which relate to Recommendation 2), and then considers issues relating to the linking rules in Recommendation 1.

Recommendation 2

- 5.2 New Zealand already denies a dividend exemption for deductible and fixed-rate dividends (section CW 9(2)(b) and (c)). Indeed, the definition of a deductible foreign equity distribution contains a simple imported mismatch rule. While this rule seems in general satisfactory, there are two situations referred to in the Final Report which New Zealand law does not deal with.

Dividends giving rise to a tax credit in the payer jurisdiction

- 5.3 First, current New Zealand law does not deal with foreign tax systems that use tax credits triggered by dividend payments to effectively refund corporate tax. This is considered in Example 1.11 of the Final Report. Such a regime has the same effect as a dividend deduction,⁴² and it is proposed that section CW 9(2)(c) be expanded to deny exemption for a dividend which gives rise to tax relief equivalent to a deduction in the payer jurisdiction.

KPMG Comment: The substance of the credit mechanism is that it allocates taxing rights away from the country of use of the equity capital. The logical conclusion is that income from equity is appropriately allocated and taxed by the country of use and the investor's country. That is what the FITC regime achieves.

Further, the Example 1.1 analysis is form based. If Country B applied an 11.1% corporate tax rate, which provides the same effective tax rate as a credit for dividends, this rule would not apply. The logical conclusion of the Report's analysis is that all dividends should be taxable with a credit for underlying foreign tax paid. This is not the reality.

Further, this would be a fundamental change which requires detailed consideration. We note specifically the costs of complying with a

⁴² The FITC regime involves a credit triggered by a dividend payment. However, this credit is used to satisfy the shareholder's withholding tax obligation, so is not equivalent to a partial deduction – see para 13 of Example 1.11, OECD 2015 Final Report. *KPMG Comment: Although this analysis is helpful to preserving New Zealand's position with regard to FITC, it illustrates the difficulties of determining whether there is a hybrid mis-match. This analysis takes a form approach. In other circumstances, the document appears to take a substance approach. The conclusion is that a hybrid mis-match is in the "eye of the beholder" (and in NZ's case, the FITC is not).*

dividend credit regime and its interaction with the CFC rules as key factors.

It appears that the mechanics of this proposal will be complex. It will require an apportionment of corporate tax to determine what is in effect deductible or not.

We further note that given activity in Country B and the effect of Country B's rules, it is difficult to see what alternative arrangements could be successfully used. Alternatives could be a branch of ACo, or a look through entity, which provides limited liability but does not attract the corporate tax credit for a distribution. Both of these appear to be at risk of the other recommendations applying – see Chapters 7 and 8 particularly. The rule will therefore affect commercial arrangements.

Denial of imputation credits

- 5.4 Secondly, there is no provision denying the benefit of an imputation credit to a dividend on a hybrid financial instrument. Example 2.1 in the Final Report (reproduced below as Figure 5.1) is an example of a deductible dividend with an imputation credit attached. The dividend is deductible in Country B because the instrument is treated as debt and funds the assets of the Country B branch. In Country A the dividend is taxed as a dividend and imputation credits are required to be attached to it by A Co, representing payments of corporate income tax to Country A. A number of Australian banks have entered into these types of transactions, in some cases using debt raised by their New Zealand branches, that is, New Zealand is Country B.

Figure 5.1: Application of Recommendation 2.1 to imputed dividends⁴³

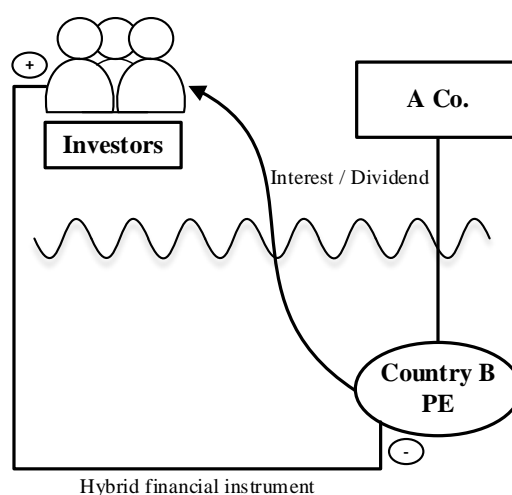

- 5.5 The Example states that under Recommendation 2.1 Country A should deny the imputation credit, because it is attached to income that has not borne tax in either state. It is true that the attachment of the credit to earnings which have not borne Country A tax may mean that A Co has retained earnings from its domestic activities which it is unable to distribute on a tax paid basis. In that

⁴³ OECD 2015 Final Report, Example 2.1, at p279.

sense the attachment of an imputation credit to a payment is less harmful than the payment being entirely exempt. However, in many cases the distribution of the untaxed earnings can be postponed indefinitely, so there is no practical distinction between exemption and full imputation.

- 5.6 Example 2.1 would not apply to a hybrid instrument issued by the foreign branch of a New Zealand company because New Zealand would tax the branch income. However, there seems no reason not to amend legislation to deny the use of imputation credits to reduce tax on a dividend which is deductible to the payer.

KPMG Comment: A valid reason for not proceeding is that if New Zealand was Country A, it would not allow a deduction for the amount Country B recognises as interest. By definition, if imputation credits are attached, the amount must be a (non-deductible) dividend.

The result would be a deductible amount in Country B, no deduction in New Zealand but the PE's income would be taxed in New Zealand. This is therefore not a hybrid mis-match result. It is countered by definition under existing domestic law.

This appears to be the case even if New Zealand proceeds with an active branch exemption. However, it may need to be considered in more detail should that occur.

The comment that "there is no practical distinction between exemption and full imputation" is only correct if retained earnings are never distributed. That has a commercial cost. Therefore, we do not believe there is direct equivalence.

- 5.7 In relation to Recommendation 2.2, New Zealand has a general rule limiting the ability to claim a credit for foreign tax to the amount of New Zealand tax chargeable on the net income that has been subject to the foreign tax. To ensure that this provision is more closely aligned with Recommendation 2.2, it is proposed that the definition of a "segment" of foreign source income be defined so that any payment of a dividend on a share subject to a hybrid transfer is treated as a separate segment of foreign source income.

KPMG Comment: Foreign tax credit rules which require detailed tracing will generate tax planning to ensure that foreign tax credits are not "trapped" or are unusable. Further consideration of a separate rule is required.

For example, as the income is a dividend, it would seem appropriate to treat this as dividend income rather than a separate segment. This is particularly the case as the only other dividends with foreign tax credits are likely to be deductible dividends. Dividends on share transfers are also taxable as deductible amounts. As they would be taxed for the same reason, they could be in the same segment.

Submission point 5A

Submissions are sought on the proposed approaches to implement Recommendation 2 where necessary.

Recommendation 1

General

- 5.8 The hybrid financial instrument rule in the OECD's Recommendation 1 applies to payments under a financial instrument that can be expected to result in a hybrid mismatch (that is, a D/NI result). A financial instrument can be either a debt or an equity instrument. For this purpose, an equity instrument would include any form of ownership interest in an entity which is not treated as fiscally transparent.
- 5.9 A simple example of a hybrid financial instrument is given in Figure 2.1 in Chapter 2.
- 5.10 A D/NI result arises when a payment is deductible to the payer, to the extent that that payment is to a person in a country where the payment would not be fully taxed within a reasonable period of time as ordinary income to a taxpayer of ordinary status, and a reason for that non-taxation is the terms of the instrument. Imposition of withholding tax on the payment by the payer country is not full taxation as ordinary income. D/NI outcomes can arise due to inconsistent characterisation of the financial instrument, or when the payer is entitled to a deduction before the payee has to include an amount in income (typically because the payer is on an accrual basis but the payee is on a cash basis).
- 5.11 The primary rule is for the payer country to neutralise the mismatch by denying the deduction. The payer country is any country where the payer is a taxpayer. It does not require the payer to be resident, and a payer can have more than one payer country. If the payer country does not deny the deduction, under the secondary rule the payee country should include the payment in the payee's income. The payee country is any country where the payee is a taxpayer.

Rule only applies to financial instruments under domestic law

- 5.12 Subject to two exceptions (considered below), countries only need to apply this rule to payments under financial instruments as characterised under their own domestic law. So, for example, a cross-border lease payment by a New Zealand-resident under a lease that is not a financial arrangement would not be subject to disallowance under this rule, even if the lessor country treats the lease payment as partially a return of principal under a finance lease.⁴⁴ The definition of a financial instrument is considered in Chapter 12.

⁴⁴ OECD 2015 Final Report, Example 1.25.

Rule only applies to payments

- 5.13 This rule only applies to payments between related parties (broadly, 25 percent or more common ownership) or structured arrangements. These definitions are discussed in Chapter 12.
- 5.14 The rule does not apply to deductions which are not for payments. Thus it does not apply to deemed deductions on an interest-free loan, but it does apply to deductions which arise from bifurcating an interest-free loan between debt and equity (Final Report, Examples 1.14 and 1.16). So, the deductions claimed by the taxpayer in *Alesco* would be disallowed by the primary rule in New Zealand, and if New Zealand did not have hybrid rules, be taxable in Australia under the defensive rule. They would not be affected by Recommendation 2, because Australia did not recognise the optional convertible note as giving rise to a dividend. The rule also does not apply to a bad debt deduction, which is attributable to a non-payment, rather than a payment – see Final Report, Example 1.20.

KPMG Comment:

The full effect of the recommendation is unclear.

The effect of the defensive rule

The paragraph implies, but does not confirm, that if New Zealand has the primary rule that its application is determined by ignoring the fact of Australia having the defensive rule. (This is the most likely scenario, given other references to Australia in the document.) We understand that this would mean that New Zealand would deny the deduction.

If so, this is an example of New Zealand applying the hybrid rules because there is no cost to doing so (it would be taxed in Australia if the deduction was not denied). This is not necessarily a “tax at a no cost” result. Tax paid in New Zealand has a different result from tax paid in Australia.

We would expect the application of the primary rule would therefore more likely than not result in different funding arrangements. As this is more likely to be debt funding, New Zealand will not increase its revenue.

Does section BG 1 still apply?

Section BG 1 was found by the Courts to apply to the Alesco facts. To the extent that continues to apply, there is no additional New Zealand tax raised by the hybrid mis-match rule.

In Alesco the taxpayer was allowed a deduction under New Zealand’s black letter law. It was denied a deduction because the GAAR applied.

The proposal is that New Zealand denies a deduction if the amount is not taxable. This will be part of New Zealand’s black letter law.

It is not clear whether, if Australia taxes this amount (by operation of a substantive rule or because of the defensive rule if our understanding on the primacy of the hybrid rules is incorrect), that means that the outcome (D/T) will be contemplated as the hybrid rules do not apply. The GAAR may not apply. The seemingly perverse outcome of implementing the hybrid rules may be that New Zealand allows a deduction. This is caused by Australia taxing the amount. (This is not intended to be a full analysis of BG 1 should the hybrids proposals proceed. It illustrates the types of issues which it will raise and which are not covered in the document.)

This confirms our general point that New Zealand's domestic rules have been developed for good reason. New Zealand's rules should be focused on achieving the outcomes that New Zealand desires independent of other countries' rules.

Further, see our comments at chapter 11 on the need to clearly establish the relationship between the hybrid rules and the GAAR.

Recommendation 2

We understand the reference to recommendation 2 is simply to confirm that Australia's implementation of recommendation 2 would not apply to tax the amount (as there is no payment).

Practical considerations

- 5.15 This rule would mean that any person claiming a deduction for New Zealand tax purposes under a cross-border financial arrangement needs to consider, before claiming the deduction, whether:
- the deduction arises as a result of a payment that (assuming no change in the parties to the arrangement) is or will be made to a related person (applying a 25% threshold, as discussed below) or pursuant to a structured arrangement; and (if the answer to the first question is yes)
 - whether under the laws of the country of the payee, the payment would be taxed as ordinary income in the hands of a taxpayer of ordinary status within a reasonable period of time. If it would not, then no deduction can be claimed.
- 5.16 Also, any person entitled to receive a payment under a cross-border financial instrument will need to consider, if that payment is not fully taxable (including where it is taxable but carries a credit, other than for foreign withholding tax), whether:
- the payment is from a related person or pursuant to a structured arrangement; and (if the answer to the first question is yes)
 - whether under the laws of the country of the payer, the payment is deductible to a taxpayer of ordinary status. If it is, then the payment is taxable in the year of the deduction.

Particular tax status of counterparty not relevant

- 5.17 Only hybrid mismatches that arise as a result of the terms of an instrument are relevant. For example, if a New Zealand borrower pays interest to a related party who is tax-exempt, there will be no hybrid mismatch if the related party would have been taxable on the interest were it not tax-exempt. However, there will be a hybrid mismatch if the related party would not have been taxable on the interest if it were not tax-exempt (Final Report, Example 1.5).
- 5.18 Another issue is the relevance of deduction or inclusion that arises only because a payer or payee holds an instrument on revenue account. Generally the principles expressed above mean that such deductions or inclusions are ignored for purposes of this rule. For example, suppose a purchaser on revenue account is entitled to a deduction for the cost of acquiring a financial instrument whereas the vendor is on capital account does not include the sale price in its income. That mismatch does not mean that the hybrid financial instrument rule applies to the payment (see Final Report, Example 1.28).

Differences in valuation of payments not relevant

- 5.19 A borrower in a foreign currency loan will generally have a foreign currency gain or loss with respect to the loan. Assuming the loan is in the currency of the lender's residence, the lender will have no corresponding gain or loss. If the borrower has a loss, the loss is not thereby denied under the hybrid mismatch rules (Final Report, Example 1.17). The situation would be the same if the loan were in a third currency, even if currency movements mean there is a foreign exchange loss to one party and a foreign exchange gain to the other.
- 5.20 However, differences in valuation that lead to different characterisations of a payment may lead to Recommendation 1 applying – see Final Report Example 1.16, relating to an optional convertible note.

Timing differences

- 5.21 Where the payer and payee under a financial instrument are in different jurisdictions, it is not uncommon for them to recognise income/expenditure from the instrument on different bases. For example, a payer may be entitled to a deduction for a payment on an accrual basis, whereas a payee is taxable on a cash basis. In that case, there is a hybrid mismatch, which is *prima facie* subject to Recommendation 1.
- 5.22 The Final Report suggests⁴⁵ that a deduction should not be denied if the payment giving rise to the deduction is included in income in an accounting period that begins within 12 months of the end of the period in which the deduction is claimed. If this test is not met, the payer should still be entitled to a deduction if it can satisfy the tax authority that there is a reasonable expectation that the payment will be made within a reasonable period of time, and once made will be included in ordinary income. A reasonable period is

⁴⁵ From p34.

one that might be expected to be agreed between arm's length parties. Final Report Example 1.21 applies these principles.

- 5.23 The Final Report does not provide for any denied deductions to be carried forward and allowed if and when the payee does recognise income.
- 5.24 The UK appears to have adopted this approach, along with a provision that if a supposition ceases to be reasonable, consequential adjustments can be made.
- 5.25 The Australian Board of Taxation Report recommends a different approach. It suggests that a gap of up to three years between deduction and inclusion should not attract operation of the rule, whereas a longer gap should mandatorily do so. It also suggests that any deduction denial should reverse when and if the payee recognises the corresponding income. This is essentially a carry-forward loss proposal. The proposal seems to mirror what would happen in the case of inclusion under the defensive rule. If the amount of a deduction in a payer jurisdiction were included in the payee's income under the defensive rule, and the payment giving rise to the income inclusion was later received, it would not be appropriate to tax the payment again, and rules against double taxation would generally achieve this. This supports the Board of Taxation carry-forward proposal in relation to the primary rule.

Taxation under other countries' CFC rules

- 5.26 When a payment gives rise to a D/NI outcome, tax may still be imposed on the payment under a CFC regime. In this case the tax would be imposed on the owners of the payee, by the owner country. This is discussed at paragraph 36 and following of the Final Report. The Report gives countries the choice as to whether to treat CFC inclusion as taxation of the payee. This would be relevant for a New Zealand taxpayer in:
- determining whether to apply the primary response – in this case the New Zealand payer would need to establish that the payment made by it was subject to tax in the hands of the payee's owners under a CFC regime; or
 - determining whether or not to apply the secondary response – in this case the New Zealand payee would need to establish that the payment made to it was subject to tax in the hands of the payee's own owners under a CFC regime.
- 5.27 The Report also says that a taxpayer seeking to rely on CFC inclusion should only be able to do so if it can satisfy the tax authority that the payment has been fully included under the laws of the CFC country. Unlike the general approach in Recommendation 1, this will require proof of actual taxation of the amount.

Application of rule to transfers of assets

- 5.28 Recommendation 1 generally does not apply to amounts paid for the transfer of an asset. However, transfers can give rise to hybrid mismatches in three different situations.

Portion of purchase price treated as payment under a financial instrument

- 5.29 First, there may be a hybrid mismatch in a cross-border asset sale if one or other country treats a portion of the purchase price of any asset as attributable to a financial instrument (see Example 1.27 of the Final Report). For example, if a purchaser is *prima facie* entitled to a deduction for a portion of a deferred purchase price under the financial arrangement rules, but the non-resident related party vendor treats the entire amount as purchase price, the hybrid financial instrument rule will deny the purchaser a deduction. Because the application of the rules depends on the tax treatment of a payment for a taxpayer of ordinary status, the linking rule will apply to deny a deduction even if the non-resident vendor is a trader and treats the purchase price as income for purposes of its home country taxation (Example 1.29 of the Final Report).
- 5.30 The Final Report also states that when a person is entitled to a deduction for a payment only because the person holds an asset on revenue account, and the person is fully taxable on their economic gain or loss from the asset, that deduction should not be denied by the linking rule (see Final Report paragraph 52 and Example 1.28). So if the purchaser in the previous paragraph is entitled to a deduction for a payment because it is a trader, that deduction should not be denied.

Hybrid transfers

- 5.31 A second way the hybrid financial instrument rule can apply to a transfer of an asset is if it is a hybrid transfer. A hybrid transfer is a transaction, such as a share loan or a share repo, where the transferor and transferee are both treated as the owner of a financial instrument. This is usually because the terms of the transfer require both that the asset, or an identical asset, is returned to the transferor, and also that the transferor is compensated by the transferee for any income from the asset that arises during the term of the arrangement (whether or not received by the transferee). This means that economic risk on the asset remains with the transferor throughout the period from the initial transfer through to the retransfer. An example of a hybrid transfer is given in Figure 2.2 in Chapter 2 of this document, which is repeated here for convenience. Further examples are the transactions that were the subject of *BNZ Investments Ltd v CIR* (2009) 24 NZTC 23,582 and *Westpac Banking Corporation v CIR* (2009) 24 NZTC 23,834.

Figure 5.2: Hybrid transfer – share repo (repeated Figure 2.2)

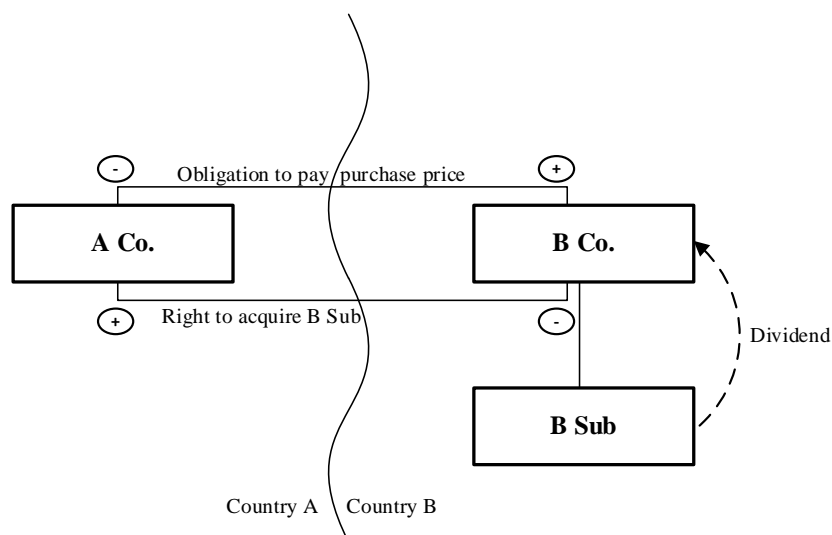

5.32 New Zealand is generally a form country, so in Figure 2.2, if B Co (the share borrower) is a New Zealand company it will be treated as owning the B Sub shares, and deriving a dividend from B Sub, rather than as having lent money to, and deriving a financing return from, A Co. However, because Country A is a substance country, A Co is treated as owning the B Sub shares, receiving the dividend, and making a deductible financing payment to B Co, equal to the amount of the dividend. Accordingly, if Country A does not have hybrid rules, and A Co and B Co are either related parties or the repo is a structured arrangement, then the effect of the hybrid transfer rule is that B Co will have to recognise additional income, unless it is taxable on the dividend from B Sub with no imputation credits.

5.33 In the case of a share loan which is a hybrid transfer, the hybrid mismatch will generally arise because:

- the manufactured dividend payment made by the share receiver to the share supplier in the substance country is treated in the same way as a dividend in the share supplier country, which will often be exempt;
- the same payment will often be deductible to the share receiver in its country.

Substitute payments

5.34 The third situation in which the hybrid financial instrument rule can apply to a transfer of a financial instrument is if the transfer involves a “substitute payment” (as defined). A substitute payment is a payment under a transfer of a financial instrument which represents a financing or equity return on the underlying instrument and which undermines the integrity of the hybrid rules. This will be the case if the underlying payment (that is, the one that gives rise to the substitute payment):⁴⁶

⁴⁶ OECD 2015 Final Report at para 79.

- is not included in the income of the substitute payer;
- would have been included in the income of the substitute payee; and
- gives rise to a hybrid mismatch.

5.35 In any of these circumstances, if the substitute payment gives rise to a hybrid mismatch, the hybrid rules will deny a deduction to the payer (primary response) or tax the payee (secondary response).

5.36 Example 1.36 of the Final Report shows a substitute payment, and is reproduced below.

Figure 5.3: Deduction for premium paid to acquire a bond with accrued interest⁴⁷

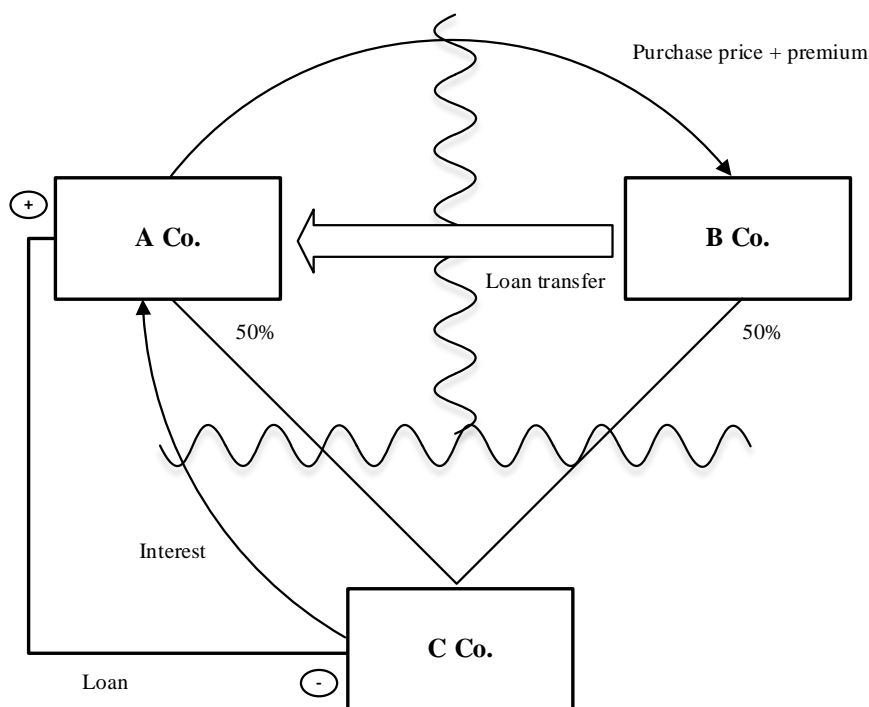

5.37 The substitute payment is the premium portion of the amount paid by A Co to B Co for the transfer of the bond with accrued interest. The transfer is neither a financial instrument, nor a hybrid transfer. However, the premium is a payment in substitution for the payment of the accrued interest. It is deductible to A Co and treated as a capital gain to B Co, so it gives rise to a hybrid mismatch. On the facts of the example, the payment by A Co to B Co is a substitute payment because the payment of the coupon to the vendor would itself have given rise to a hybrid mismatch. The result would be the same if the coupon payment were taxable to the vendor. Accordingly, if the purchaser and vendor are related, or the sale is a structured arrangement, the payment of the premium will be subject to the hybrid mismatch rule.

⁴⁷ OECD 2015 Final Report, Example 1.36, at p274.

Regulatory capital

5.38 The Final Report gives countries the option to exclude regulatory capital from their hybrid rules. A typical example is when the parent company in a multinational banking group issues regulatory capital instruments to the market for the purpose of using the funds to provide regulatory capital to a bank subsidiary in another country. Countries are free to exclude the intra-group regulatory capital from the hybrid rules. The Final Report also states that an exclusion of bank regulatory capital from one country's rules does not require any other country with hybrid rules to refrain from applying them to regulatory capital instruments between the two countries.

Other exclusions

5.39 Recommendation 1.5 provides an exception to the primary response for investment vehicles that are subject to special regulatory and tax treatment that:

- is designed to ensure that while the vehicle itself has no tax liability, its investors have a liability, arising at more or less the same time as the gross investment income was derived by the investment vehicle; and
- ensures that all or substantially all of the vehicle's investment income is paid and distributed to the owners within a reasonable period after the income is earned; and
- taxes the owners on the payment as ordinary income.

5.40 An example is a regulated real estate investment trust, which is entitled to a dividend paid deduction but required to pay out all of its earnings on a current year basis.

Application to New Zealand

5.41 A number of issues are worthy of further discussion and submission as to how Recommendation 1 could be incorporated into New Zealand law.

Applying the secondary rule to hybrid dividends

5.42 In New Zealand's case, the secondary rule (taxation of amounts that are deductible in the payer jurisdiction) will also require the denial of imputation credits attached to a dividend which is deductible in another jurisdiction. This could arise in the situation set out in Example 1.23 of the Final Report, reproduced below, where New Zealand is Country B.

Figure 5.4: Payment by a hybrid entity under a hybrid financial instrument⁴⁸

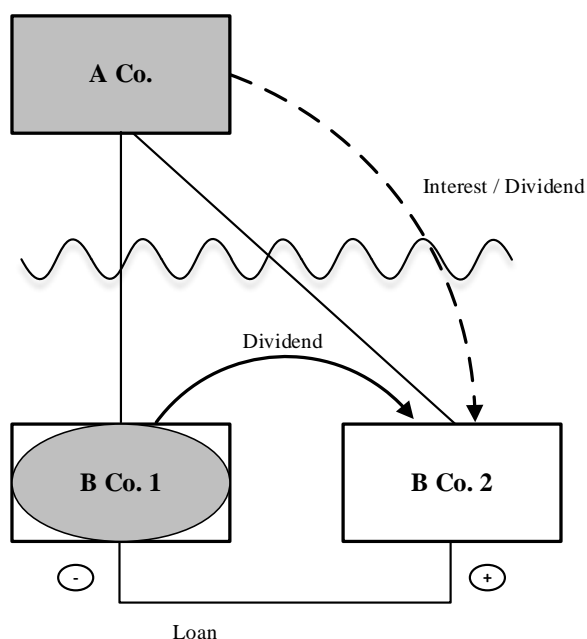

5.43 Accordingly, the Government proposes to amend the law so that imputation credits attached to a dividend on a hybrid financial instrument are not included in a New Zealand shareholder's income and do not give rise to a tax credit. This non-inclusion would not affect the paying company. This ensures that application of the rule does not allow two lots of imputation credits to exist for what is in reality the same income. Denial of one amount of imputation credits correlates with the fact that the dividend payment has given rise to a foreign tax benefit.

5.44 As this example makes clear, implementing the defensive rule in Recommendation 1 will also require New Zealand to tax intra-group dividends that give rise to a hybrid mismatch under the hybrid financial instrument rule, even if these are between members of a 100 percent commonly owned group (whether or not consolidated).

KPMG Comment: *In both cases, the proposals protect the foreign country's, and not New Zealand's, tax base. The dividend is correctly treated as capable of having imputation credits attached and as being exempt under New Zealand's domestic rules.*

In the first scenario, it is not clear whether B Co 2 would still have imputation credits received recorded in its ICA. These may be important to ensure that there is no double taxation when profits are ultimately distributed. However, further ICs may not be required as tax paid by B Co 2 on the dividend would generate imputation credits.

⁴⁸ OECD 2015 Final Report, Example 1.23, at p235.

Submission point 5B

Submissions are sought on whether there are any issues with the proposed approach in applying the secondary rule to hybrid dividends.

Timing mismatches

5.45 With respect to timing mismatches, the Australian Board of Taxation approach (see earlier paragraph 5.25) may have advantages for New Zealand. Denial of deductions (with carry forward) where there is a deferral of recognition of the corresponding income for more than three years:

- applies or not based on objective criteria which can be applied on a self-assessment basis, that is, without the need for the Commissioner to exercise any discretion; and
- seems both economically appropriate and consistent with the application of the secondary rule.

KPMG Comment: The application of this rule in New Zealand is unprincipled as:

- *withholding tax will be paid on the basis that a deduction is available so there is double taxation (unless the hybrid rules apply before the deemed payment for withholding tax applies, but we note the contrary is proposed, see chapter 11);*
- *the treatment of the amount as incurred and deductible is based on principled approaches to the allowance of deductions;*
- *any period is arbitrary if it does not have regard to the commercial terms of the arrangement. For example, commercial loan terms are often structured to match expected cashflows from a project. Such loans should not be subject to the rules.*

Submission points 5C

Submissions are sought on:

- whether the approach recommended by the Australian Board of Taxation would be an acceptable one for New Zealand;
- what alternatives might be better to deal with timing mismatches; and
- what thresholds should apply to determine when the rule would apply to a difference caused by different income and expenditure recognition rules.

Effect of CFC inclusion on application of Recommendation 1

5.46 The need to treat CFC taxation of a payee's owner to be treated as taxation of the payee itself is not pressing in the case of the secondary response. Taxation

of the payee in the payee country under the defensive rule is likely to simply reduce CFC taxation in the owner country.

- 5.47 Given the complexity of establishing the extent to which taxation under a CFC regime should be treated as inclusion for purposes of the hybrid rules, the fact that there is no need to do so when applying the secondary response, and the fact that there are usually alternatives to the use of hybrid instruments, it is not proposed to treat CFC taxation as relevant in applying Recommendation 1.

KPMG Comment: We consider these proposals are unprincipled. The application of CFC rules in the owner's country will potentially overturn the D/NI conclusion, which justifies the application of the hybrid rules in the first place. If double non-taxation is the true target of the rules, then the rules should only apply if there is in fact double non-taxation.

We appreciate the complexity that this might bring but note:

- *With self-assessment, the onus is on the taxpayer to show that the foreign CFC rules apply to tax the amount;*
- *A hybrid may correctly prevent double taxation if CFC rules apply;*
- *Alternatives may be less commercially applicable.*

Submission point 5D

Submissions are sought on whether this approach as to CFC inclusion will give rise to any practical difficulties.

Taxation of FIF interests

- 5.48 If a New Zealand resident holds shares subject to the FIF regime, and accounts for those shares using the fair dividend rate (*FDR*), cost or deemed rate of return (*DRR*) method, the dividends on those shares are not taxable. Instead the resident returns an amount of deemed income. Dividends are only taxable if the holder uses the comparative value (*CV*) or attributable foreign interest (*AFI*) method (note that when those two methods are being used, if the dividend is deductible in the foreign country it will not be exempt in New Zealand even if the shareholder is a company).
- 5.49 FIF taxation therefore presents at least two problems for applying Recommendation 1.
- The non-resident payer of a deductible dividend to a New Zealand payee, if resident in a country with the hybrid rules, will not know how a New Zealand taxpayer of ordinary status would treat the dividend, and therefore will not know whether, or to what extent, it is denied a deduction for the dividend by the primary response in its own country.
 - When the New Zealand payee is applying the defensive rule (in a case where the non-resident payer of a deductible dividend has not been denied a deduction), if the payee is not applying the CV or AFI method,

the payee will need to determine how much of the dividend has not been taxed, in order to know how much additional income to include.

5.50 Possible solutions are to:

- deny the FDR, cost and DRR methods to shares on which any dividend would be deductible to the payer. This would be similar to the existing requirement to use the CV method for a non-ordinary (generally, debt-like) share (section EX 46(8));
- include a deductible dividend in the holder's income, in addition to income already recognised under the FDR, cost or DRR method. This would be similar to the exclusion of deductible dividends from the general exemption for foreign dividends received by New Zealand companies in section CW 9 (though this exclusion does not apply to interests accounted for under the FDR, DRR or cost method);
- include a deductible dividend in the holder's income only to the extent that it exceeds the income otherwise recognised on the shares. This is somewhat similar to the concept of a top-up amount (defined in section EX 60) that applies when a person uses the DRR method.

5.51 As long as one of these solutions is adopted, there should be no need for a non-resident payer of a deductible dividend to a New Zealand payee to apply the primary response.

KPMG Comment:

Principle

It is not clear why the FIF rules present any hybrid concerns. The FIF rules have been deliberately designed to tax a deemed rate of return as proxy for dividend income (through the FDR regime). This was set at a rate that was expected to exceed the actual dividend yield from overseas investments. The aim was to broadly tax a dividend yield approximating what an Australasian listed stock would pay.

The fact that the FIF rules are a "code" was a deliberate design choice. The FDR method was aimed at broadly aligning with the tax position of a NZ investor in NZ shares. The application of hybrid rules, would result in New Zealand taxing FIF investments more heavily than domestic investments

In our view, Officials should clearly articulate the policy of the FIF rules to support the view that the technical exemption of a dividend from a FIF does not produce a D/NI result. No specific hybrid rule is required.

Breadth of application

We have corresponded with Officials regarding our concerns of the breadth of the definition of structured arrangement (see chapter 12) and its interaction with this analysis. There is a real potential for the hybrid rules to inappropriately override the FIF rules in unrelated scenarios.

This will potentially impact compliance for PIEs and others, including “mum and dad” investors, which rely on the certainty of the FDR method. The latter are likely to be able to apply the hybrid rules in a cost effective way.

Officials should ensure that the rules as they are drafted and are applied (if it proceeds) does not inappropriately override the FDR method.

Submission point 5E

Submissions are sought on which of these FIF approaches would be preferable and why, and whether there is another better approach.

Transfers of assets: revenue account holders

- 5.52 Recommendation 1 could apply to an asset transfer involving a New Zealand party. For example, suppose a New Zealand resident purchases an asset from a related party on deferred payment terms, and is entitled to deduct a portion of the price as financial arrangement expenditure. If the vendor treats the entire amount as being from the sale of the asset, then there will be a hybrid mismatch, and the purchaser will be denied a deduction for the expenditure.
- 5.53 The treatment if the New Zealand resident is acquiring the asset on revenue account (for example, because it is a trader), is less clear. As set out above, the Final Report states that where a person is entitled to a deduction for a payment only because the person holds an asset on revenue account, and the person is fully taxable on their economic gain or loss from the asset, that deduction should not be denied by the linking rule.
- 5.54 However, revenue account holders are not entitled to include in the cost of trading stock the element of their purchase price which is treated as financial arrangement expenditure (section EW 2(2)(d)). The denial of a deduction for that expenditure under the linking rule would not include it in the cost of trading stock. Also, non-taxation of income (for example, dividends on shares accounted for under the FDR method) is not turned off for revenue account holders. So, it is not the case that revenue account holders are always subject to income tax on all of their economic income.
- 5.55 Given that New Zealand does not tax revenue account holders on the basis referred to in paragraph 52 of the Final Report (referred to above), it is not proposed to exempt revenue account payers from the effect of the hybrid rule.

KPMG Comment: *We refer to our comments on the FIF analysis above for the comments in 5.54.*

The non-inclusion of financial arrangement expenditure as part of the cost of the trading stock/revenue account property does not justify the application of the rule. The reason that amount is not included in the

cost is to ensure the expenditure is not double counted. It gives priority to the financial arrangement rules for the timing of the deduction. The result of the New Zealand rules is that the full economic gain is taxed albeit at different times.

Put another way, the document's analysis appears to be:

- New Zealand, on a principled basis, deems an amount to be interest and not the cost of property;
- This justifies treating the deemed interest amount as non-deductible.

This analysis is unprincipled and illogical, in our view. Clearly, revenue account holders should be exempt from the rules.

Submission point 5F

Submissions are sought as to whether revenue account holders should have an exemption from the rules.

Transfers of assets: hybrid transfers

- 5.56 New Zealand does have some specific tax rules for share loans and repos (the rules applying to returning share transfers and share lending arrangements, both as defined in the Income Tax Act 2007). Generally, these do not treat the share supplier as continuing to own the shares (though there is an exception for returning share transfers when the share supplier uses the FDR method to determine its income from foreign shares).⁴⁹ The closest they come is that in relation to a share lending arrangement the share supplier is treated as owning a *share lending right* for the period of the arrangement.
- 5.57 As referred to above, New Zealand has unique rules relating to the taxation of dividends on foreign shares. While dividends from ASX listed shares are generally taxable, other dividends on foreign shares may or may not be taxable.
- 5.58 Again, the New Zealand tax regime creates a difficulty for both counterparty countries (in this case, the country where the repo or share loan counterparty is resident, rather than where the share issuer is resident) and for New Zealand. Again, it would be possible to solve these issues by having a rule which would ensure that dividends paid on foreign shares to a New Zealand person who is party to a hybrid transfer with respect to the shares are always taxable, applying one of the approaches referred to in paragraph **Error! Reference source not found.** The taxation of dividends paid on New Zealand shares held by a New Zealand share receiver who is a party to a hybrid transfer would be unchanged, unless the defensive rule was applied. In that case, the dividends would be taxable with no credit for any imputation credits on the dividends (see Final Report, Example 1.32).

⁴⁹ See sections EX 52(14C) and EX 53(16C), Income Tax Act 2007.

KPMG Comment: *It is difficult to follow what exactly is proposed in this section. To the extent it relies on the earlier analysis for FIF investments, the same comments as above apply.*

Submission point 5G

Submissions are sought on whether this proposal for amending the income tax treatment of a New Zealand resident who holds shares subject to a hybrid transfer would be a practical response.

Regulatory capital

5.59 The UK proposes to take up the option to exclude bank regulatory capital instruments from its regime in certain circumstances (see discussion at Chapter 8 of *Tackling aggressive tax planning* (HM Treasury and HMRC, December 2014)). However, we understand that the UK has existing anti-hybrid rules that apply to bank regulatory capital. The Australian Board of Taxation Report sought an extension of time to report on this issue.

5.60 It is not proposed that bank regulatory capital is excluded from the implementation of hybrid mismatch rules in New Zealand.

KPMG Comment: *See the comments above regarding the likely increased cost to New Zealand of applying the hybrid rules to bank regulatory capital. This is due to the likely lower rate that applies to hybrid capital and that its replacement would be debt and not equity for the New Zealand branch.*

At a minimum, implementation of the hybrid rules should be deferred until Australia decides on its approach and its rules are confirmed. Australia's approach may make any inclusion of bank regulatory capital moot.

Submission point 5H

Submissions are sought on whether there are any issues with providing no exclusion for regulatory capital.

5.61 The exemption of an instrument from the hybrid rules in one country does not require exemption of that same instrument by others (Final Report, page 11). A decision by a country not to fully implement the rules is not intended to bind other countries in their own implementation. That is true even in an area where non-implementation is an option provided by the Final Report. Whether it is

intended or not, a hybrid mismatch causes the same loss of overall tax revenue, and gives rise to the same difficulties of attributing that loss.

Other exclusions

- 5.62 We note that the UK legislation proposes an exception for hybrid transfers to which a financial trader is a party (section 259DD).⁵⁰ The Board of Taxation has recommended that consideration be given to an exception for financial traders entering into repos and securities-lending agreements. It is not clear that sufficient activity of this kind is taking place to justify an exception of this kind in New Zealand.

Submission point 5I

Submissions are sought on whether such an exception is necessary or desirable, and how it should be designed.

- 5.63 New Zealand does not seem to have any entities requiring an exception under Recommendation 1.5 from the primary response. In particular, PIEs are not entitled to a deduction for their distributions, and are not required to distribute their income within any period.

KPMG Comment: New Zealand investors will invest in foreign PIE equivalents who may be seen to have a deduction for distributions made to an investor. We refer particularly to Australian Unit Trusts. From a New Zealand perspective, the Australian entity pays no tax due to it distributing (by the vesting income in beneficiary rules) to investors who are taxed or not.

Investments in such vehicles should be explicitly excluded from the secondary response.

Submission point 5J

Submissions are sought on whether there are any other New Zealand entities that should be eligible for this exemption.

- 5.64 Finally, although the main target of the rule is cross-border transactions, the OECD recommendations can also apply to payments within a country (see Final Report, Examples 1.13 and 1.21). This means that the hybrid financial arrangement rule might deny deductions in purely domestic transactions in some circumstances. However, the focus of the hybrid mismatch rules should

⁵⁰ Section 259DD of Schedule 10 of the Finance (No.2) Bill (United Kingdom).

be on cross-border activity and accordingly it is proposed that domestic transactions are specifically excluded from the application of the rules.

KPMG Comment: *We agree.*

CHAPTER 6

Disregarded hybrid payments

- 6.1 This chapter considers Recommendation 3 of the Final Report; the disregarded hybrid payments rule. The rule applies when a deductible cross-border payment has been disregarded by the payee country due to that country's treatment of the payer. This generally results in a D/NI outcome. This outcome can be counteracted by the disregarded hybrid payments rule through a denial of deduction in the payer country (the primary response), or an inclusion of income in the payee country (the secondary response or defensive measure).
- 6.2 The disregarded hybrid payments rule only applies if the parties to the hybrid mismatch are in the same control group or are party to a structured arrangement (both defined in Chapter 12).
- 6.3 Figure 2.3 in Chapter 2 of this document is an example of a disregarded hybrid payment structure.

Requirements for rule to apply

- 6.4 A disregarded payment is one that is deductible in a country where the payer is a taxpayer (the payer country) and is not recognised as a payment in any country in which the payee is a taxpayer (the payee country).
- 6.5 A hybrid payer is an entity that is treated by the payee country in a manner that results in a payment by the entity being disregarded.
- 6.6 An example of a hybrid payer entity in New Zealand is an unlimited liability company wholly owned by a US parent. The company is fiscally opaque in New Zealand but treated as a foreign branch of the US parent in the US. Accordingly when it makes a payment to its parent, there is a deduction in New Zealand but no inclusion in the US.
- 6.7 The question of whether an entity is a hybrid payer will not turn on a preordained list of entities and no characteristics in and of themselves would qualify an entity as a hybrid payer. Moreover, an entity that is considered to be a hybrid payer in one scenario may not be a hybrid payer under a different scenario. See for instance, Example 3.2 of the Final Report, reproduced below as Figure 6.1.

Figure 6.1: Disregarded hybrid payment using consolidation regime and tax grouping⁵¹

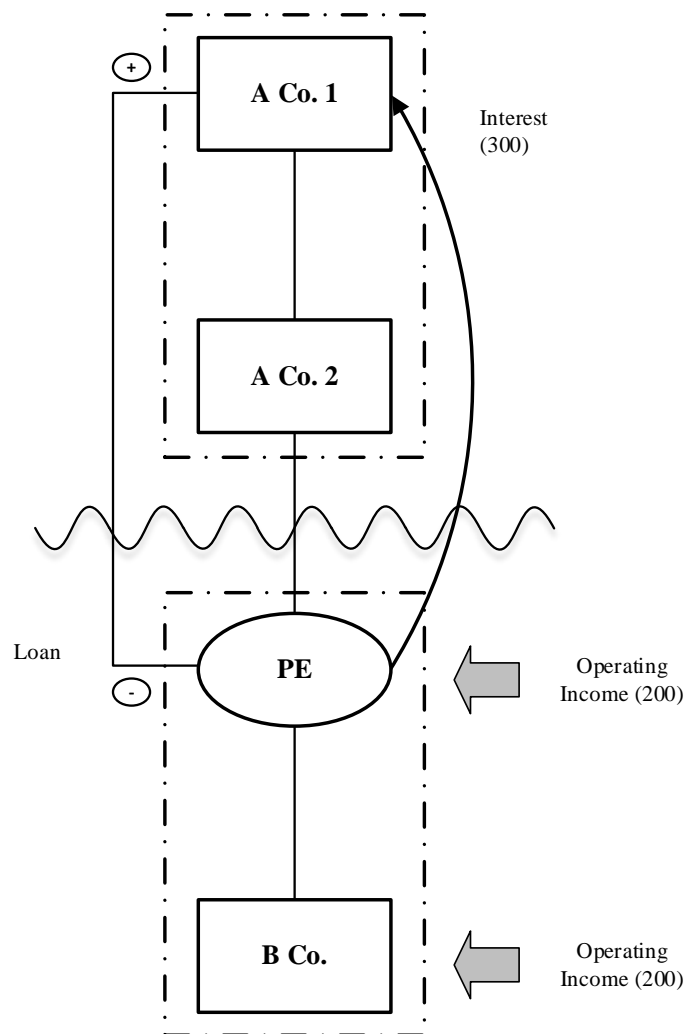

- 6.8 In this case, the election by A Co 1 and A Co 2 to consolidate for tax purposes results in a disregarded payment and the classification of A Co 2 as a hybrid payer. It is the fact of consolidation rather than the particular characteristics of A Co 2 that mean that the company is a hybrid payer.
- 6.9 It is possible for a disregarded payment to arise as a result of a deemed payment between a branch and another part of the same legal entity. In some countries, if funds or an asset, attributable to a foreign entity’s operations in a foreign country is provided to a domestic branch of the same legal entity, the domestic branch is entitled to a deduction for a notional payment for the provision of the funds or asset. If the foreign country does not recognise this payment, there is a disregarded payment.

Dual inclusion income

- 6.10 The disregarded hybrid payment rule will not apply to the extent that the payer’s deduction is offset against income that is dual inclusion income.

⁵¹ OECD 2015 Final Report, Example 3.2, at p293.

- 6.11 Dual inclusion income is ordinary taxable income in the payer country and in the payee country. Dual inclusion income is also relevant to the deductible hybrid payments rule and to the double deduction and dual resident payer rules which are discussed in Chapters 8 and 9 respectively.
- 6.12 The exclusion from the rule for disregarded payments offset by the payer against dual inclusion income recognises that a taxpayer's circumstances may create a tax advantage through a disregarded payment in the payer country which is neutralised by taxation in the payee country. The advantage is neutralised because the payee country taxes the dual inclusion income with no deduction for the disregarded payment.
- 6.13 Differences in the way that each country treats income in terms of timing or valuation will not prevent the classification of an item of income as dual inclusion income. This is demonstrated in Example 6.1 of the Final Report. In that example, different timing rules apply in the payer and parent countries to the calculation of dual inclusion income, which means that different amounts are affected by the hybrid rule depending on whether the primary or defensive rule applies. The payer country's calculation of the dual inclusion income is used to make the primary response whereas the payee country's calculation would be used to make the defensive response.
- 6.14 The Final Report recommends that items that are taxed as income in one country and are subject to a type of double taxation relief in the other country can nonetheless be classified as dual inclusion income.⁵² Dual inclusion income includes an equity return that is:
- taxable in the payee country (whether or not with an underlying foreign tax credit); and
 - granted a tax credit or exemption in the payer country, which is designed to avoid economic taxation.
- 6.15 An example of dual inclusion income that is subject to double taxation relief in one country is Example 6.3 of the Final Report. In that example, a dividend received by a hybrid payer is allowed an intra-group tax exemption in the payer country but is subject to tax in the payee country due to the dividend recipient (hybrid payer) being treated as fiscally transparent in the payee country.
- 6.16 A further example of dual inclusion income is if B Sub 1 in Figure 2.3/6.1 pays an exempt or fully imputed dividend to B Co, provided that dividend is subject to tax in Country A.
- 6.17 Broadly speaking, the effect of allowing a D/NI payment to be deducted against dual inclusion income but then applying Recommendation 3 as to any excess is that to the extent of the D/NI payment, any net loss incurred by or through the hybrid entity:

⁵² OECD 2015 Final Report at para 126.

- is unable to be used to offset any other income in the payer country (primary rule); or
- is unable to be used to offset any other income in the payee country.

The qualification to that statement is that it is only entirely true if all of the income derived by or through the payer entity is dual inclusion income. If some of it is not dual inclusion income, the amount of the D/NI payment that may not be deducted will be increased by that amount.

Example

Take the example in Figure 2.3/6.1. Suppose that the interest payment to A Co is \$300, and that in addition, B Co has \$50 of income and B Sub 1 has \$100 of net income. The \$50 income earned by B Co would *prima facie* be taxable also to A Co, and is therefore dual inclusion income. The \$100 earned by B Sub 1 would not be taxable to A Co and therefore would not be dual inclusion income.

Accordingly, under the primary rule, Country B would deny B Co a deduction for \$250 of the interest. B Co would have no net income or loss, and B Sub 1 would have \$100 income. A Co would have \$50 income.

Under the defensive rule, Country A would tax A Co on \$250 of interest. The result of the defensive rule would be a loss in Country B of \$150 (after offset of \$100 of B Co's \$250 loss against B Sub 1's income), and income for A Co in Country A of \$300 (the \$50 of income earned by B Co plus \$250 under the Recommendation 3 defensive rule).

Carry-forward of denied deductions

- 6.18 Any deduction denied under the disregarded hybrid payments primary rule may be carried forward to a future year to be offset against excess dual inclusion income (that is, dual inclusion income against which a hybrid deduction has not already been taken).
- 6.19 Carry-forward would be subject to the existing continuity of ownership rule that applies to the carry-forward of losses.

Example

Take the example above. Suppose the only event in year 2 is that B Sub 1 pays a dividend to B Co of \$100, which is exempt to B Co in Country B but taxable to A Co in Country A. The dividend is dual inclusion income. If the primary rule applied in year 1, in year 2 \$100 of the \$250 portion of the interest deduction disallowed in year 1 under the primary rule would be deductible to B Co in year 2, giving it a net loss of \$100 in Country B, which it is free to use in accordance with Country B tax rules (for example, it can be grouped with the income of another group member).

However, if the defensive rule applied in year 1, the Final Report does not provide for reversal of the \$250 income recognised by A Co.

Submission point 6A

Submissions are sought on whether there are any issues with using the rules for the carrying forward of tax losses as a basis for the treatment of carrying forward disallowed deductions.

KPMG Comment: The effect of denying the deduction is to treat the expenditure as not incurred or to match that expense against the income that it generates. If the denial of the deduction is principled, there is no reason to subject the expense to a carry-forward rule. It will be properly deducted against the income that it generates. To deny a deduction would be to over-tax when there is no net income to tax.

Application of CFC regimes

- 6.20 The Final Report states (paragraph 127) that an item of income can be dual inclusion income if it is the ordinary income of a company subject to tax in one country and is attributed income for the shareholder of the company in another country under a CFC regime. The Final Report recommends that for a taxpayer to claim an item of income to be dual inclusion income, they must demonstrate to the relevant tax authority that the effect of the CFC regime is that the item of income is subjected to full rates of tax in two countries.

Implementation issues

- 6.21 To calculate its dual inclusion income, a taxpayer must detect all instances where two countries will consider the same item to be included as income. This task could involve substantial compliance costs where a taxpayer has many cross-border payments and where payments are recognised in different ways by the countries. The Final Report suggests that countries should aim to introduce implementation solutions that maintain the policy intent of the rules while reducing the compliance costs that taxpayers may encounter in assessing their dual inclusion income.⁵³
- 6.22 Taxpayers generally prepare accounts of income and expenditure in the countries they operate in. This information could be used as an initial basis for identifying dual inclusion income. A document containing this information with identified dual inclusion income items should be maintained by the taxpayer to support the claiming of a deduction for a D/NI payment (and, if the payer country does not apply the primary rule, non-inclusion of such a payment under the secondary rule).
- 6.23 The Final Report proposes⁵⁴ that, to apply the disregarded hybrid payments rule primary response, the total claimed deductions for disregarded payments would be limited to the extent of the total identified dual inclusion income of the taxpayer. The defensive response would be achieved by requiring payee country entities to recognise income to the extent that deductions claimed in the payer country exceed dual inclusion income.

⁵³ At para 130.

⁵⁴ Example 3.1; paras 13–14.

- 6.24 Another implementation solution suggested by the Final Report (Example 3.2, reproduced in Figure 6.1) is in relation to a consolidated group that crosses two countries (for example, where a member has a branch in another jurisdiction, or where a member is a resident of another jurisdiction). The Final Report proposes that in applying the primary response the payer country could prevent a hybrid payer from using a loss of the payer country consolidated group to the extent that deductions have been claimed in the payer country for payments that were disregarded under the law of the payee country. For the defensive response, the payee country would require a resident entity to include as income the hybrid payer's deductible payments that are disregarded in the payee country to the extent that they result in a net loss (taking into account dual inclusion income) in the payer country. The Final Report further suggests that specific measures would be needed to ensure that the parties involved in a transaction cannot circumvent these rules by allocating non-dual inclusion income to the hybrid payer in order to offset its losses.

KPMG Comment: The principled response is to allow taxpayers to show that income is dual inclusion. In New Zealand's self-assessment regime that would be required in any case.

We would also expect that if existing systems do not already track material amounts that such systems would be developed. This would potentially be in conjunction with systems developed to comply with CbC reporting requirements.

We note that if such evidence is not available a deduction would be denied.

Submission point 6B

Submissions are sought on the practicalities of assessing a taxpayer's dual inclusion income, the feasibility of the implementation options described above, as well as any other implementation solutions for the successful operation of dual inclusion income rules in New Zealand.

Application to New Zealand

Carry-forward/reversal of defensive rule income

- 6.25 The Final Report does not propose a carry-forward rule for the application of the defensive rule. This creates a potential for over-taxation in a scenario where the defensive rule is applied to include extra income in the payee country and excess dual inclusion income arises in a later year.
- 6.26 A solution to this problem may be to provide for a "reversal" rule whereby the application of the defensive rule in the payee country could be reversed (through an allowable deemed deduction) in a later year where there is excess dual inclusion income.

- 6.27 Alternatively, the defensive rule could be limited so that income is only included to the extent that the disregarded payment deduction is offset against non-dual inclusion income in the payer jurisdiction. In the event that there is no non-dual inclusion income that the payment can be offset against, the income inclusion could be suspended until non-dual inclusion income is present. Unlike the reversal approach, this option would require the payee country tax authority and payee jurisdiction taxpayers to be aware of the level of non-dual inclusion income being earned in the payer country.

KPMG Comment: The reversal rule appears easier to apply, subject to the comments above regarding continuity rules.

We note that it is not clear what 6.27 actually proposes.

Submission point 6C

Submissions are sought on whether it is appropriate to depart from the OECD's recommendations in this regard, and which approach would be best to take.

Dual inclusion income

- 6.28 As with Recommendation 1, it is proposed that CFC income is not able to be included as dual inclusion income. This will avoid drafting a large amount of very detailed and targeted legislation, aimed at situations that are unlikely to arise, and that in all likelihood will not deal appropriately with the peculiarities of such situations when they do arise.

KPMG Comment: See our comments above. We consider this proposal unprincipled as it does not attempt to prevent double taxation. CFC income should be able to be included as dual inclusion income.

We agree that the legislation is likely to be complex to be appropriately targeted. The rules should be as clear as possible. Therefore, their implementation may also justify a consolidation and re-write of the CFC and FIF rules which the Finance and Expenditure Select Committee has already recommended.

Submission point 6D

Submissions are sought on whether it is appropriate to depart from the OECD's recommendations in relation to CFC income as dual inclusion income.

CHAPTER 7

Reverse hybrids

- 7.1 A reverse hybrid is an entity where some or all of whose income is (or can be):
- in its establishment country, treated as derived by its investors (generally its owners); and
 - in an investor country, treated as derived by the entity.
- 7.2 A New Zealand limited partnership may be an example of such an entity. For New Zealand tax purposes, the income of a New Zealand limited partnership is taxable to the partners. However, if a partner is resident in a country that treats the partnership as an entity separate from the partners for its tax purposes (for example, because it has separate legal personality) the partnership is to that extent a reverse hybrid. Look-through companies can also be reverse hybrid vehicles in New Zealand (though recent proposed law changes will limit the ability for conduit income to be earned through a look-through company). A New Zealand trust may also be a reverse hybrid. For New Zealand tax purposes, income which is treated as beneficiary income is taxed to the beneficiary, not the trustee. However, if the beneficiary is resident in a country which does not recognise trusts, the income may not be treated by the beneficiary's residence country as derived by the beneficiary, particularly if it is not actually distributed to the beneficiary.
- 7.3 An example of a reverse hybrid giving rise to a hybrid mismatch is in Figure 2.5 (repeated below from Chapter 2).

Figure 7.1: Payment to a reverse hybrid (repeated Figure 2.5)

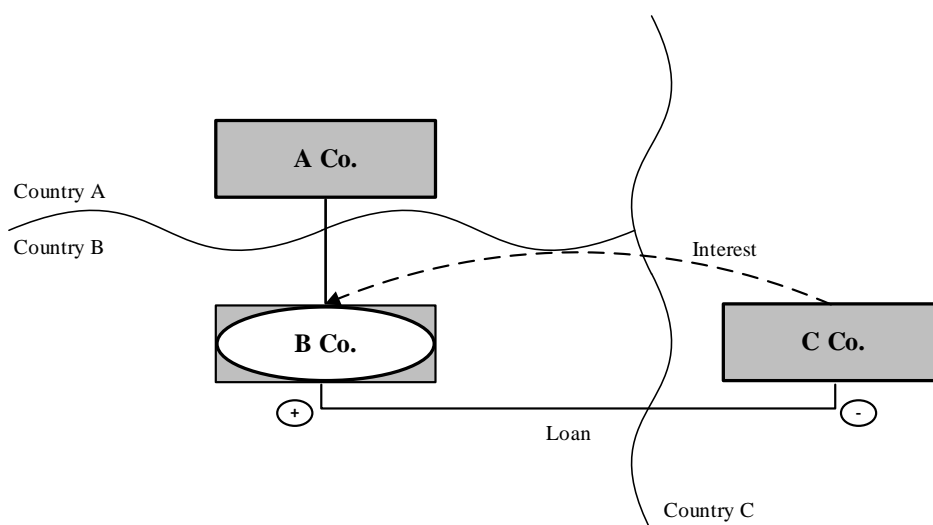

Branches as reverse hybrids

- 7.4 When a country does not tax its residents on income from foreign branches, a mismatch of rules between that country and the country where a branch is located can lead to a reverse hybrid result. This can occur if a payment to a person is treated in the residence country as non-taxable because it is attributed to a foreign branch, but in the branch country the payment is also not taxed, because the branch country either:
- does not treat the person as having a branch; or
 - treats the payment as not attributable to the branch.
- 7.5 Accordingly, Recommendations 4 and 5 are also applicable to branches in these situations. The branch is analogous to the reverse hybrid entity, and the head office to the investor.

Recommendation 4

- 7.6 Recommendation 4 is when a D/NI payment is made to a reverse hybrid, and the payment would have been included in income if it were made directly to the investor; the payer country should deny a deduction for the payment. The Recommendation also applies if the payment would have given rise to a hybrid mismatch under the hybrid financial instrument rule if made directly to the investor. As with the disregarded payments rule, this rule can apply to any deductible payment.
- 7.7 Taxation of an investor in its home country on a subsequent distribution by the reverse hybrid of the income does not prevent a payment being subject to disallowance under this Recommendation (Final Report, paragraph 156).
- 7.8 Many trusts – for example, most family trusts, do not have investors as such. For the purposes of this rule, an investor is any person to whom income is allocated by a reverse hybrid. So it would include any person who is allocated beneficiary income.
- 7.9 The Recommendation will not apply if the reverse hybrid establishment country taxes as ordinary income the income allocated to the non-resident investor – for example, on the basis that the reverse hybrid is carrying on business in the establishment country.
- 7.10 The rule only applies if either:
- the investor, the reverse hybrid and the payer are members of the same control group; or
 - the payment is under a structured arrangement to which the payer is a party.
- 7.11 The definitions of a control group and a structured arrangement are in Chapter 12.

7.12 There is no defensive rule for reverse hybrids. This is on the basis that if a country adopts Recommendation 5, there is no need for a defensive rule.

Recommendation 5

7.13 Recommendation 5 contains three further recommendations regarding tax rules for reverse hybrids as follows:

- Countries should ensure that their CFC and other offshore investment regimes are effective to prevent D/NI outcomes arising in respect of payments to a reverse hybrid in which their residents are investors.
- Countries should tax reverse hybrids established in their own country to the extent that their income is allocated to non-residents who are not taxable on the income because they are resident in a country that treats the reverse hybrid as fiscally opaque. This recommendation would only apply if the non-resident investor is in the same control group as the reverse hybrid.
- Countries should introduce appropriate tax filing and information reporting requirements on tax transparent entities established within their country in order to assist non-residents and tax administrations to determine how much income has been attributed to their investors.

7.14 The proposed application of Recommendations 4 and 5 in New Zealand is considered below.

Application in New Zealand

Recommendation 4

7.15 From a New Zealand perspective, it will be New Zealand payers rather than New Zealand payees who are affected by New Zealand legislating for this recommendation. There do not seem to be any particular New Zealand-specific issues raised by Recommendation 4 that have not already been discussed in relation to the other Recommendations. Implementing the rule will simply involve denying a deduction if the necessary conditions are satisfied.

KPMG Comment: As above generally and relevant.

Submission point 7A

Submissions are sought on whether there are any issues relating to implementing Recommendation 4 in New Zealand.

- 7.16 From the perspective of other jurisdictions making payments to New Zealand, we note that a foreign investor PIE would seem to be a reverse hybrid, depending on the treatment of the investors in their home countries (see Final Report, paragraphs 161 and 162). However, a payment to a foreign investor PIE would not be subject to disallowance in most cases, due to the scope limitation of Recommendation 4.

***KPMG Comment:** This conclusion seems to be contrary to the comment above regarding deductions for PIEs. It also ignores the technical answer that the PIE is in fact taxable on the payment made, it is simply taxed at a “nil” rate. This is a specific policy decision. It highlights the need to determine whether the result is a hybrid outcome or a deliberate “exemption”. The foreign investor is not taxed or looked through to under the New Zealand tax rules.*

We refer above to our concerns regarding the scope of the structured arrangement definition. We consider that the last sentence is not clearly correct.

Recommendation 5.1: CFC and other offshore investment regimes

- 7.17 This recommendation is for New Zealand to ensure that a payment to a CFC that is fiscally transparent in its establishment country with respect to the payment is caught by the CFC regime, that is, that it is taxed to New Zealand investors in the CFC, if those investors are subject to tax under the CFC regime. In this way, the CFC regime would be used to turn the reverse hybrid into an ordinary fiscally transparent entity, at least insofar as it allocates income to New Zealand investors.
- 7.18 One way to address this would be to treat any person who has an interest in a CFC, as determined under subpart EX, to derive an amount of income from the CFC equal to the amount allocated to that person by the reverse hybrid for income tax purposes in its establishment country, and which is not taxed in the establishment country because of that allocation. This figure will already have been calculated by the CFC, and so should be readily available to the investor. In the case of an entity that is only partially transparent only the untaxed income would be subject to the CFC regime.
- 7.19 This is the approach suggested in paragraph 173 of the Final Report. It would override the rules which generally apply to the calculation of CFC income. In particular:
- attribution would not be limited to the types of income specified in section EX 20B, being generally passive or base company income;
 - the exemption for non-attributing Australian CFCs would have to be amended such that reverse hybrid entities established in Australia would be excluded from the exemption;
 - the amount of income taxable in New Zealand would be determined under the tax rules of the establishment country, rather than under New Zealand tax rules. This is different from the approach taken for foreign entities which New Zealand treats as fiscally transparent – for example,

foreign general partnerships. An investor's taxable income in such entities must be calculated under New Zealand income tax rules. While this ensures that income from foreign sources is determined in the same way as income from domestic sources, it does require an additional element of compliance, and can lead to either double taxation or double non-taxation, either on a temporary or permanent basis; and

- the amount allocated to an investor would not be determined by reference to the investor's income interest as calculated under New Zealand tax rules, but by reference to the investor's percentage share of the entity's income as determined by the rules of the establishment country (though the two would usually be the same or very similar).

KPMG Comment: *This section does not clearly detail the interaction with the active income exemption. It appears to suggest that the active income exemption would be overridden if the CFC's income is attributed to the New Zealand investor. It is not clear why such an override is required (given that it would not be taxed in New Zealand).*

7.20 This recommendation would also apply to the attributable foreign income method under the foreign investment fund (FIF) regime. It would not seem necessary to apply it in relation to the other FIF methods, which already tax on an accrual basis. While there are certain exemptions from the FIF regime, these do not seem to be available to a reverse hybrid, because all of them require that the non-FIF entity is liable to tax either in Australia or in a grey list country. This requirement might need to be modified to ensure that the exemptions are not available to partially transparent entities.

7.21 Trusts established in a foreign jurisdiction with a New Zealand resident settlor are already fully taxable, that is, it is not possible for such a trust to be a reverse hybrid. However, if a payment received by a foreign or non-qualifying trust which has foreign trustees is:

- attributed to a New Zealand beneficiary under the laws of that foreign country and therefore not taxed in that country; and
- not taxed by New Zealand, for example, because it is treated by New Zealand as trustee income that is not subject to New Zealand tax, the foreign trust is to that extent a reverse hybrid.

KPMG Comment: *It is not clear that this can be achieved under New Zealand's trust laws. New Zealand treats an amount as beneficiary income if it was paid or applied to the beneficiary. It is not clear what foreign rule would be broader than this rule so that it was treated as beneficiary and not trustee income. (We would expect the reverse to apply.) Further, if there were such a gap, the payment when made to the beneficiary, as sourced from trustee income, would be a taxable distribution. The document's concern seems to be theoretical.*

- 7.22 The mismatch could be resolved by treating such a payment as beneficiary income for New Zealand tax purposes. This should not be problematic from an administrative perspective, since the records of the trust in the establishment country would generally reflect in some way the allocation of the income to the beneficiary.
- 7.23 Alternatively, New Zealand could depart from the OECD's approach and achieve the intention of Recommendation 5.1 through a different type of rule.
- 7.24 The UK has drafted a narrower rule than that in Recommendation 5.1. Its rule includes an amount in the income of a UK investor which is derived through a reverse hybrid only to the extent of a D/NI mismatch in respect of a payment to the reverse hybrid that is not counteracted in another jurisdiction.⁵⁵ This rule resembles the "defensive" parts of other OECD recommendations, such as the hybrid financial instrument rule (Recommendation 1) and the disregarded hybrid payments rule (Recommendation 3). However, this rule is more complex in that it requires the investor to determine whether or not a particular payment has given rise to a D/NI outcome and whether or not that has already been counteracted.
- 7.25 Australia already has a set of rules that seek to counteract mismatches arising from reverse hybrid entities established in other countries.⁵⁶ These rules provide that a specified list of foreign entities are treated as partnerships under Australian law to the extent that they are tax-transparent in their establishment jurisdiction. The rules therefore link the tax treatment in Australia to the overseas tax treatment and ensures that the untaxed income of the foreign entity will flow through to its Australian investors on an apportioned basis.

KPMG Comment: Consistent with our view, this appears to be a more principled approach as it goes part way to aligning definitions of opaque/transparent treatment of entities.

However, we note the difficulty with this approach is that it imports definitions without subjecting them to the consultative process.

We consider a better approach would be to agree with Australia a common definition of opaque/transparent entities which could be included in New Zealand's domestic law.

- 7.26 New Zealand taxes residents on the income they derive through foreign branches, so Recommendation 5.1 does not require any change in that respect.

KPMG Comment: The document does not appear to have any regard to the questions that arise in chapter 8 for foreign branches. It supports our view that the proposals, because of their breadth and the lack of co-ordination, risks creating an incoherent New Zealand tax regime.

⁵⁵ Section 259GD, Schedule 10, Finance (No. 2) Bill 2016.

⁵⁶ Division 830, Income Tax Assessment Act 1997.

Submission points 7B

Submissions are sought on whether it would be best for New Zealand to:

- follow the OECD's Recommendation 5.1 and amend its CFC rules as discussed above; or
- adopt a more limited approach as in the UK; or
- link the New Zealand tax treatment of income earned through a foreign entity to the treatment in the jurisdiction where that entity is established, as Australia has done on a limited basis.

If the OECD approach is to be followed, how could New Zealand's CFC regime best be adapted to impose New Zealand tax on income allocated to a New Zealand resident by a reverse hybrid?

Submissions are also sought on the desirability or otherwise of changes to New Zealand's trust and FIF regimes for the purpose of implementing Recommendation 5.1.

Recommendation 5.2: Taxation of reverse hybrids established in New Zealand

7.27 Under this rule New Zealand would tax the foreign source income of (for example) a New Zealand partnership as if it were a company, to the extent that income is allocated to a non-resident 50 percent partner who treats the partnership as fiscally opaque. The ownership threshold is necessary to the example because the scope of the recommendation is limited to investors who are in the same control group as the reverse hybrid. If New Zealand turned off its transparency in this kind of case, neither payer nor investor country would need to apply their reverse hybrid rule to that payment. This approach would also apply to payments that are not deductible (and therefore not subject to Recommendations 4 or 5.1). A dividend paid by a foreign company to a New Zealand partnership with a majority foreign owner who treats the partnership as exempt would be subject to New Zealand tax on the same basis as if the partnership were a company.

7.28 This rule could apply to limited and general partnerships, and to foreign investor PIEs, to the extent those entities derive foreign sourced income which is allocated to foreign investors. It could also apply to a New Zealand foreign trust (a trust with a New Zealand trustee but no New Zealand settlor, and usually no New Zealand assets), to the extent that the trust allocates foreign income as beneficiary income to a non-resident beneficiary in the same control group as the trust.

7.29 There is also an argument in favour of New Zealand taxing the foreign source trustee income of a New Zealand trust to the extent that that income is not taxed in any other country. The non-taxation of foreign-sourced trustee income of a New Zealand foreign trust is premised on the non-residence of the settlor. The trustee income is, in a sense, allocated to the non-resident settlor for the purpose of determining New Zealand's right to tax. Accordingly, if the settlor is in the same control group as the trust, it would seem logical to apply

Recommendation 5.2 to tax the trustee income, if it is not taxed to the settlor or any other person.

7.30 The definition of a “control group” is discussed in more detail in Chapter 12. The definition is designed to apply to partnerships and trusts as well as to corporate groups. Example 11.1 of the Final Report demonstrates that:

- the power to appoint a trustee of a trust is treated as a voting interest in the trust;
- where a settlor’s immediate family are the beneficiaries of a trust, they will be treated as holding equity interests in the trust, and these equity interests will be deemed held by the settlor under the “acting together” test.

7.31 This rule also suggests that New Zealand should tax the non-New Zealand source income of a non-resident if the non-resident’s home country:

- treats the income as attributable to a New Zealand branch; and
- on that basis, exempts it from tax.

KPMG Comment: The treatment of a foreign trust has been recently considered by the Independent Review of New Zealand foreign trusts. It concluded that New Zealand’s principled approach is correct. We see no reason to depart from that conclusion.

We further note that a “New Zealand foreign trust” is not defined. See our submissions on the Taxation (Business Taxation, Exchange of Information and Remedial Matters,) Bill. The scope of this change is potentially significant.

Submission points 7D

Submissions are sought on whether and to what extent reverse hybrid entities established in New Zealand should (or should not) become taxable on their income under the principle of Recommendation 5.2. In particular, should trustee income earned by a New Zealand foreign trust be subject to New Zealand tax if the requirements of Recommendation 5.2 are met?

Submissions are also sought on the proposal to tax income treated by another jurisdiction as attributable to a New Zealand branch, and accordingly not subject to tax, as taxable in New Zealand, even if it otherwise would not be.

KPMG Comment: There does not appear to be any detailed discussion of the latter proposal?

Recommendation 5.3: Information reporting

7.32 Recommendation 5.3 is that countries should have appropriate reporting and filing requirements for tax transparent entities established in their country. This involves the maintenance by such entities of accurate records of:

- the identity of the investors (including trust beneficiaries);
- how much of an investment each investor holds; and
- how much income and expenditure is allocated to each investor.

7.33 Recommendation 5.3 states that this information should be made available on request to both investors and the tax administration.

7.34 Naturally, New Zealand's record-keeping and reporting requirements are focussed on ensuring compliance with the obligation to pay New Zealand tax. They are not generally designed to provide information regarding the derivation of income that New Zealand does not tax. However, the requirements vary. Taking the simple example of a tax transparent entity which is established under New Zealand law but has no New Zealand owners or assets:

- For a general and a limited partnership, there is a requirement to file an IR7 and also an IR7P. The IR7 requires overseas income to be recorded, and the IR7P requires the partners to be identified and the allocation of income to them. This seems to satisfy the requirements of Recommendation 5.3.
- A look-through company is subject to the same record keeping and return filing requirements as a New Zealand partnership. It also must allocate its income and deductions between its owners (Tax Administration Act, section 42B(2)).
- For a New Zealand foreign trust (one where the settlor is not New Zealand resident), the trust is required to keep records allowing the Commissioner to determine its financial position (Tax Administration Act, section 22(2)(fb) and (m)). It must keep records of settlements made on and distributions made by the trust. It is also required to keep particulars of the identity of the settlor and distributees, if known (Tax Administration Act, section 22(7)). The trust also has to provide the identifying particulars of the trust and the address of the New Zealand resident trustees (Tax Administration Act, section 59B). There does not seem to be any requirement for the trust to file a tax return if it has no New Zealand source income.
- For a foreign investor PIE, a return must be filed in the prescribed form (TAA section 57B). In order for foreign investors to not be subject to New Zealand tax at 33% (***KPMG Comment: Note should be 28%?***) on the PIE's foreign income, they must provide to the PIE their name, date of birth, home address, and tax file number in their home country and New Zealand (Tax Administration Act, section 28D).

7.35 With the exception of trusts, New Zealand seems to already be compliant with Recommendation 5.3. The record-keeping and disclosure requirements for New Zealand foreign trusts was separately dealt with by the Government Inquiry into Foreign Trust Disclosure Rules, released on 27 June 2016.⁵⁷

KPMG Comment: We can see no justification for further changes beyond those already proposed for foreign trusts and by the application of the Automatic Exchange of Information rules for investors generally.

⁵⁷ <http://www.treasury.govt.nz/publications/reviews-consultation/foreign-trust-disclosure-rules>

CHAPTER 8

Deductible hybrid payments

- 8.1 Recommendation 6 concerns payments that are deductible in two countries. A simple example is a payment made by a company's foreign branch. If the company is resident in a country that, like New Zealand, taxes foreign branch income, this payment will often be deductible both in the branch country and in the residence country. The same outcome arises if expenditure is incurred by an entity which is fiscally transparent in a country where one or more of its owners is resident (such as a New Zealand unlimited liability company with a US owner).
- 8.2 To the extent that such a payment is deducted in one country against income that is not taxed in the other country, the payment produces double non-taxation. This is shown in Figure 2.4, reproduced below.

Figure 8.1: DD arrangement using hybrid entity (repeated Figure 2.4)

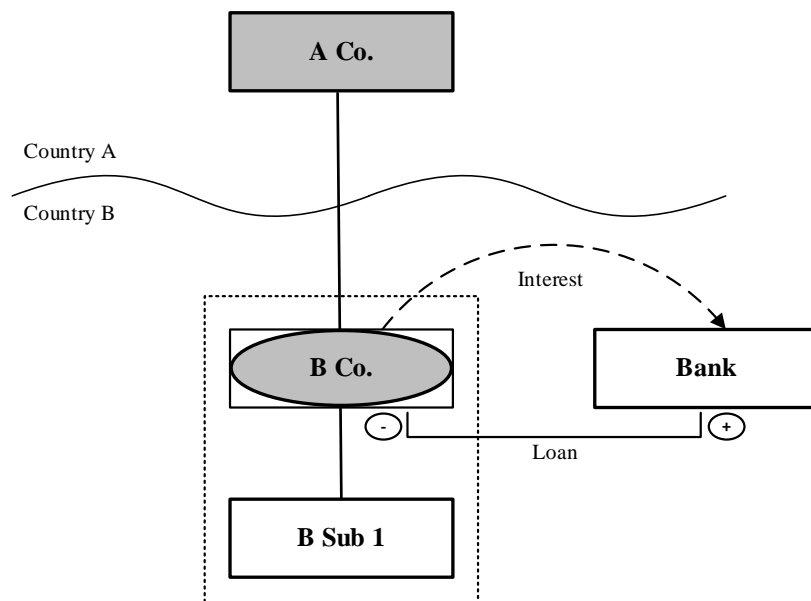

- 8.3 The primary response in Recommendation 6 is for the parent country to deny a deduction for the payment, to the extent it exceeds dual inclusion income (income taxed in both countries). The parent country is the country where the payer is resident (in the case of a branch), or where an owner of the payer is resident (in the case of a hybrid entity). There is no limitation on the scope of this rule.
- 8.4 The secondary response (which applies only to deductions that are not subject to the primary response) is for the payer country to deny a deduction for the payment, to the extent it exceeds dual inclusion income. The defensive rule applies only if either the payer is a branch, the owner and the payer are in a control group, or the payer is party to a structured arrangement.

- 8.5 Where a foreign tax credit is available in the parent jurisdiction in relation to an item of dual inclusion income, the Final Report proposes that the foreign tax credit can only be used to the extent of the tax liability in the parent jurisdiction on the net dual inclusion income (dual inclusion income less deductions) that arises. This is discussed in Example 6.4 of the Final Report, in particular paragraphs 13 and 14.

Application to New Zealand

- 8.6 The primary response means that in most cases a New Zealand resident will not be able to claim an immediate deduction for a foreign branch loss except against income from the same country. This is because in most cases it will be possible for those losses to be used to offset non dual-inclusion income in the branch country. Unless it can be shown that such an offset is not possible, those losses will have to be carried forward and used either:
- to offset net income from the branch in future years;
 - without restriction, if the losses have become unusable in the branch country, for instance because the branch has been closed down before the losses have been used or because of an ownership change. In this case the losses are referred to as “stranded losses”.
- 8.7 This denial extends to all forms of deductions – for example, it applies to depreciation and amortisation (Final Report, paragraph 192). It only applies to expenditure which is actually deductible. Thus, it will not apply to expenditure for which a deduction is denied under (for example) Recommendation 1 or Recommendation 4.
- 8.8 The secondary response will require New Zealand to introduce a rule denying both New Zealand branches of non-residents and non-resident owned New Zealand hybrid entities the ability to deduct expenditure against income which is not also taxable in the parent country, if that expenditure is not subject to the primary response in the parent country. Most obviously, this will deny such branches or entities the ability to group a loss against the profit of a commonly owned New Zealand entity (unless that entity is also a hybrid whose income is taxable in the parent country). It will also deny them a deduction for their expenditure against their own income if that income is for some reason not taxed in the parent country. An example is income earned through a reverse hybrid (see Example 6.1 of the Final Report).
- 8.9 As discussed in paragraph 200 and Example 6.5 of the Final Report, where the secondary response applies but the owner who is claiming a deduction in the parent country does not own all of the payer, the hybrid rules require the inclusion, in the payer country, of more than the amount which is deductible in both countries. This is necessary so that the amount of additional income allocated to that owner is sufficient to reverse the deduction.

KPMG Comment:

Foreign branch

There is merit in considering an exemption for active income of a foreign branch. We note that this has been on New Zealand's tax policy agenda for some time but has not been progressed.

It has the advantage of equalising the treatment of a CFC and a foreign branch.

We further note that it may eliminate the need for the proposals in chapter 7.

Amount denied

The comments at paragraph 200 and the example at 6.5 are not clear.

Submission points 8

Submissions are sought on whether the denial of a deduction for foreign branch losses against New Zealand income should be matched by an exemption for active income earned through a foreign branch. This would put foreign branches of New Zealand companies in a similar New Zealand tax position to foreign subsidiaries.

Submissions are also sought on any other aspect of the proposals relating to implementation of the OECD's Recommendation 6 in New Zealand.

CHAPTER 9

Dual resident payers

- 9.1 Recommendation 7 applies to dual resident entities. It is similar to Recommendation 6, in that it deals with a situation where a single payment is deductible in two countries. However, in this case there is only one entity involved, and both countries regard it as a resident. Since it is not easy to differentiate between the two countries, Recommendation 7.1 is for both countries to deny the deduction to the extent that it is offset against non-dual inclusion income. As with Recommendation 6, any deduction that is disallowed can be offset against dual inclusion income arising in a later period.
- 9.2 Since only one taxpayer is involved, there is no limitation on the scope of Recommendation 7.
- 9.3 If both residence countries have hybrid rules, it is possible for the disallowance to give rise to double taxation – for example, if it is offset against non-dual inclusion income in both jurisdictions (see Final Report, Example 7.1). However, given that dual residence status is in most cases deliberate rather than accidental, it should be possible for taxpayers to be aware of the possibility of double taxation, and by adopting simpler structures, avoid it.

Application to New Zealand

- 9.4 New Zealand already denies a dual resident company the ability to use a loss to offset the income of other group companies (section IC 7(2)) and to join a tax consolidated group (section FM 31). While this substantially limits the kinds of structures that can give rise to double non-taxation using a dual resident company resident in New Zealand, it does not mean that there are no such opportunities. For instance, New Zealand could not be Country A in the Final Report's Example 7.1, but it could be Country B.

KPMG Comment: *It is not clear how New Zealand being Country B could advantage the group in the example. A Co 2 must by definition be dual resident in New Zealand and Country A. This would generally prevent it offsetting the funding loss against BCo's profit. (We assume the operating income amounts should be positive rather than negative in the Example 7.1.)*

It does not appear that anything is required.

- 9.5 The dual resident payer rule raises a number of issues that have been considered in previous chapters. In particular:
- because a deduction is allowed to the extent of dual inclusion income, dual inclusion income needs to be defined – this is considered in Chapter 6;

- determining whether or not a payment is deductible in the other country may require that issue to be determined earlier than when a deduction arises in that country, in which case the ordinary rules applying in that country should govern the question. At the same time the question requires certain entity specific rules in that country to be taken into account;
- the rule can sensibly apply to non-cash deductions such as depreciation and amortisation. Accordingly it is not necessary to restrict it to payments;
- some equity returns that are tax exempt or tax credited on the basis that they are paid out of tax paid income should still be treated as dual inclusion income;
- disallowed amounts should be able to be carried forward and offset against dual inclusion income arising in a later year. Carry-forward will be limited in the same way as it is limited for losses;
- attributed income under CFC rules cannot be treated as dual inclusion income;
- credit for underlying foreign taxes may be limited; and
- if an entity is unable to carry forward its disallowed loss in one country, the other country can allow the loss to be deducted (see Final Report, Example 7.1 paragraph 13).

Submission point 9A

Submissions are sought on the OECD's Recommendation 7 and any issues that may arise in relation to its implementation in New Zealand.

DTA dual resident rule suggestion

- 9.6 In Chapter 13 of the Final Report it is suggested that countries should consider inserting into their domestic law a rule that deems an entity not to be resident if that entity is resident of another country through the operation of a DTA.⁵⁸
- 9.7 If incorporated into New Zealand law, this rule would prevent an entity benefitting from a mismatch between New Zealand's domestic law definition of residence and the definition of residence found in any of New Zealand's bilateral DTAs.
- 9.8 Canada⁵⁹ and the UK⁶⁰ have domestic law to this effect. New Zealand law currently features a series of provisions that ensure that an entity that is non-resident under a DTA cannot access various features of the New Zealand tax

⁵⁸ At para 432.

⁵⁹ Section 250(5) of the Income Tax Act 1985 (Canada).

⁶⁰ Section 18 of the Corporation Tax Act 2009 (United Kingdom).

system (such as maintaining an imputation credit account).⁶¹ However, New Zealand's rules are not comprehensive, which potentially allows room for abuse. In particular, a company could manipulate its place of effective management under a DTA to avoid New Zealand's corporate migration rules (as they do not provide for a company becoming non-resident under a treaty).

***KPMG Comment:** The non-application of the company emigration rules to residency under a DTA was deliberate. There is no analysis to justify a departure from that rule.*

The broader consequences of deeming a non-resident under a DTA to also be non-resident under domestic law is not considered.

For example, a number of New Zealand's DTAs would not protect distributions by such a company of New Zealand sourced income. See article 10, paragraph 8 of the Australia DTA as an example. This would seem to apply to allow New Zealand to tax what would be taxed under the company emigration rule when the distribution is made.

By contrast, deeming such a company to be non-resident would prevent future New Zealand taxation of distributions of New Zealand sourced income. This may be the right outcome as a dual resident is not able to maintain an ICA and a shareholder would be double-taxed as a result.

Submission point 9B

Submissions are sought as to the OECD's DTA dual resident rule suggestion.

⁶¹ See, for instance, sections FN 4, FO 3, HA 6, IC 7, and OB 1 of the Income Tax Act 2007.

CHAPTER 10

Imported mismatches

- 10.1 Recommendation 8 in the Final Report relates to imported mismatches. It requires a country to deny a payer a deduction for a payment (an *imported mismatch payment*) which meets all of the following requirements:
- is made to a payee in a country that does not have hybrid mismatch rules;
 - does not itself give rise to a hybrid mismatch;
 - which the payee sets off against a *hybrid deduction*, that is, a deduction for a payment that gives rise to a hybrid mismatch, or a deduction for a payment made to a third person which is offset by that third person against a payment giving rise to a hybrid mismatch.
- 10.2 The rule only applies if the payer is in the same control group as the parties to the hybrid mismatch, or the arrangement is a structured arrangement to which the payer is a party.
- 10.3 The rule is not limited to payments in relation to financial instruments. There is no defensive rule requiring inclusion by payees.
- 10.4 The objective of the rule is to increase the effectiveness of the hybrid rules. Importantly, the rule will not apply to a payment to a person in a country that has implemented hybrid rules.
- 10.5 The imported mismatch rule is potentially complex to apply. It will require knowledge of the tax consequences of a wide range of transactions within a group. On the other hand, if a group is structured in a straightforward way, and monitors the existence of hybrid mismatches in intra-group transactions, it is likely that the necessary information will be readily available.
- 10.6 Figure 2.6 (in Chapter 2 of this document) contains a simple example of an imported hybrid mismatch in a structured arrangement, and is reproduced again here.

Figure 10.1: Imported mismatch from hybrid financial instrument (repeated Figure 2.6)

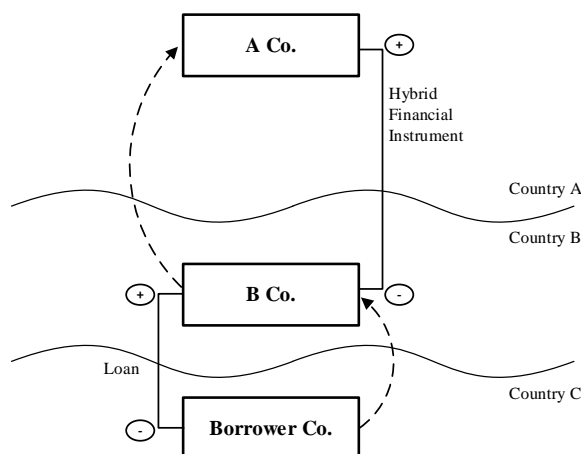

10.7 The arrangement involves A Co providing financing to B Co by way of a hybrid financial instrument, with B Co then lending that money to Borrower Co in Country C. Suppose that Country C is the only one with hybrid rules. Leaving aside the imported mismatch rule, the result of the arrangement is:

- a deduction for Borrower Co;
- no net income to B Co (because its income from the loan equals its deduction on the hybrid instrument); and
- no income to A Co (because Country A treats the financing as equity and does not tax the dividend).

The overall outcome is double non-taxation.

10.8 Accordingly, under the imported hybrid mismatch rule, Borrower Co would be denied a deduction for the lesser of its interest payment and the interest payment by B Co.

Non-structured imported mismatches

10.9 Final Report Examples 8.3 to 8.9 in particular demonstrate the application of the direct and indirect imported mismatch rule. These rules apply to payments within a control group. They apply when a payment is made by a payer in a country with hybrid rules to a payee in a country without hybrid rules, to the extent that payee is:

- a payer under a hybrid mismatch (in which case there is a direct imported mismatch); or
- a payer to a payee who is in turn a payer under a hybrid mismatch (in which case there is an indirect imported mismatch).

Application to New Zealand

10.10 As it is part of the OECD recommendations, it is proposed that New Zealand should introduce an imported hybrid rule. Multinational groups with Australian or UK members will already need to be keeping track of uncorrected hybrid mismatches for the purpose of compliance with the rules in those countries, so the imposition of such a rule by New Zealand should not involve significant additional costs. This may require the New Zealand members of the group to have access to information held within the group but outside New Zealand. This should not be problematic, in a control group context.

KPMG Comment: *The document does not refer to other jurisdictions and their requirement, or otherwise, to maintain the relevant documentation. There will be additional compliance for multi-national groups with no Australian or UK presence.*

Refer to our comments on “control group”. A control group is wider than a parent-subsidiary relationship. Given this wider definition, access to information is likely to be problematic.

- 10.11 Accordingly, an imported mismatch rule that is introduced in New Zealand should, so far as possible, be consistent with the rules adopted by the UK and Australia. For instance, the Australian Board of Taxation has noted that a de minimis/safe harbour test may be appropriate for the imported mismatch rule in Australia.

KPMG Comment: We refer to our earlier comments on the justification for the hybrid rules generally.

We further note that adopting this recommendation implies that the hybrid recommendations would not be widely adopted. (It appears to apply because intermediate countries have not adopted hybrid rules.) This appears to weaken the justification for New Zealand’s implementation – that global adoption will benefit New Zealand.

This recommendation should not be immediately pursued. It will require complicated legislation and compliance will be difficult.

It is therefore better to see if it is required if global implementation does not occur.

Submission point 10

Submissions are sought on whether New Zealand should adopt an imported mismatch rule as recommended by the OECD, and what matters may need to be considered in order to ensure that the rule works as intended, with compliance costs reduced so far as possible.

CHAPTER 11

Design principles, including introduction and transitional rules

- 11.1 Final Report Recommendation 9 contains recommendations for:
- the design of the hybrid rules, including their interaction with other parts of the legislation, and
 - introduction and transitional issues, and how countries should implement the hybrid rules.

Design and interaction

General

- 11.2 Most of the design principles in Recommendation 9 are uncontroversial, and it is proposed that they would be utilised if the OECD recommendations were adopted in New Zealand. Adhering as closely as possible to the OECD recommendations is more likely to create rules that are:
- Comprehensive. This is important so that the rules do not leave open or create hybrid planning opportunities, while imposing unnecessary compliance costs.
 - Consistent with those adopted by other countries. This will go some way to creating a single set of rules, so that the rules do not give rise to unintended gaps or overlaps, and anyone who is familiar with hybrid rules in one country will have a good idea of how they work in another. Nevertheless, some variations between countries are inevitable.

Ordering of hybrid rules

- 11.3 As recommended in the Final Report (paragraph 286), it is proposed that the OECD recommendations would apply in the following order if implemented in New Zealand:
- hybrid financial instrument rule (Recommendation 1)
 - reverse hybrid rule (Recommendation 4) and the disregarded hybrid payment rule (Recommendation 3)
 - imported mismatch rule (Recommendation 8)
 - deductible hybrid payment rule (Recommendation 6) and the dual resident entity rule (Recommendation 7).

Interaction of hybrid rules and withholding tax

- 11.4 In accordance with the OECD recommendations, we propose that denial of a deduction for a payment under any of the hybrid rules would not affect its withholding tax treatment.

KPMG Comment: See our comments above. We consider the OECD recommendation is unprincipled as it will lead to double taxation. For New Zealand to proceed with that rule perpetuates an unprincipled approach. This is especially the case for deductions which are deferred pursuant to an arbitrary time limit.

We consider that as the hybrid rules are targeted (they apply to particular instruments and entities with particular cashflows), New Zealand's withholding tax rules should be modified if the proposals proceed.

Interaction of hybrid rules and transfer pricing

- 11.5 It is proposed that taxpayers are able to apply the hybrid rules in priority to the transfer pricing rules. This will ensure that to the extent a payment is disregarded under the former, there is no need to undertake a transfer pricing analysis.
- 11.6 When a New Zealand taxpayer is required to include an amount in income under Recommendations 1, 3 or 4, the amount included would be net of (reduced by) any transfer pricing adjustment in the payer country.

Interaction of hybrid rules and thin capitalisation

- 11.7 Where a deduction is disallowed for an amount of interest under the primary rule in Recommendation 1, or under Recommendations 4 or 8, it is proposed that the thin capitalisation rules be applied on the basis that the disallowed interest and the debt relating to that interest are both disregarded. This will produce the same result as if the interest was a dividend and the debt was equity. It will prevent any double deduction denial of the same payment.
- 11.8 The interaction with thin capitalisation rules and Recommendations 3, 6 and 7 is more complex due to the carry-forward rule which has no equivalent in New Zealand's thin capitalisation regime. Due to the carry-forward rule, if the disregarded hybrid payments rule applies before thin capitalisation, a permanent deduction denial under thin capitalisation could be replaced by a deduction denial under anti-hybrid rules which may be reversed by the carry-forward rule in a later year (due to excess dual inclusion income).
- 11.9 To address this problem without giving rise to double denial of interest expense, it is proposed that the carry-forward rule is limited such that the amount of denied deductions able to be carried forward is reduced by the amount of adjustment that would have occurred under thin capitalisation rules if there was no hybrid counteraction. With this limitation, the hybrid rules can apply before thin capitalisation and the intended result of New Zealand's thin

capitalisation rules will be preserved in the event of a carry-forward deduction being allowed in a future year.

- 11.10 In applying the defensive rule in Recommendation 1 or 3, or Recommendation 2, a New Zealand payee should not consider the thin capitalisation adjustments made by a payer jurisdiction. This is the same approach that is applied to a straightforward interest payment received by a New Zealand payee from a foreign payer. The amount of taxable income is not reduced on account of any interest denial in the payer jurisdiction.

KPMG Comment: This approach appears to be overly complex. The simple principle is a denied deduction is not subject to the thin capitalisation rules. The thin capitalisation rules aim to deny otherwise deductible amounts if the taxpayer breaches allowed debt funding ratios.

See our comments above regarding the effect of the denial and carry-forward. It is either a deferral of the incurred rule or a matching rule. In either case, the thin capitalisation rules would apply to confirm or otherwise a deduction allowed at the appropriate time.

- 11.11 Table A sets out the interaction between the hybrid rules and the thin capitalisation and transfer pricing rules.

Table A: Interaction of recommendations with other deduction denial rules

	Recommendation	Transfer pricing	Thin capitalisation
1	Recommendation 1		
1.1	Primary rule – deny deduction in payer jurisdiction.	Primary rule first, and then transfer pricing. Saves having to do a transfer pricing analysis in cases where the deduction will be denied in any case.	Primary rule first, then thin capitalisation rules. When applying thin capitalisation, ignore disallowed interest, and treat hybrid debt as equity. Ensures no double disallowance.
1.2	Secondary rule – income inclusion in payee jurisdiction.	Do not apply hybrid rules to the extent a deduction is disallowed by transfer pricing in payer jurisdiction.	Apply secondary rule regardless of any thin capitalisation disallowance in payer jurisdiction – it is issuer-specific. Result is the same as if the payment were interest under a simple debt. Same applies to non-deductibility due to direct use of borrowed funds – see Final Report, paragraph 28.
2	Recommendation 2		
2.1	Dividend inclusion in payee jurisdiction.	As for Recommendation 1 secondary rule.	As for Recommendation 1 secondary rule.
3	Recommendation 3		

	Recommendation	Transfer pricing	Thin capitalisation
3.1	Primary rule – deduction denial in payer jurisdiction.	Transfer pricing first, then primary rule. Because primary rule allows carry-forward, transfer pricing has to be done anyway.	Primary rule first. However, carry forward reduced to the extent that thin capitalisation would have disallowed a deduction if hybrid rules had not applied. Because primary rule allows carry-forward and thin capitalisation does not, if carry forward is not reduced, deductions will avoid thin capitalisation scrutiny, or have the wrong ratio applied.
3.2	Secondary rule – income inclusion in payee jurisdiction.	Do not apply hybrid rule to the extent a deduction is disallowed by transfer pricing in payer jurisdiction.	As for Recommendation 1 secondary rule.
4	Recommendation 4		
4.1	Primary rule – deduction denial in payer jurisdiction.	Primary rule first, and then transfer pricing. As for Recommendation 1.	Primary rule first, then thin capitalisation. As for Recommendation 1.
5.	Recommendation 5		
5.1	5.1 – improvements to CFC regimes.	Not a linking rule – transfer pricing treatment in payer jurisdiction not relevant – only tax treatment in establishment jurisdiction. But if an interest payment is subject to a transfer pricing adjustment in the payer jurisdiction and we have a treaty with them, the payee could ask for a correlative adjustment.	Not a linking rule – thin capitalisation treatment in payer jurisdiction not relevant – only tax treatment in establishment and owner jurisdictions.
5.2	5.2 – limiting tax transparency for non-resident investors.	As for Recommendation 5.1, except right to a correlative adjustment clearer.	As for Recommendation 5.1.
6	Recommendation 6		
6.1	Primary rule – deny deduction in parent jurisdiction.	As for Recommendation 3 primary rule.	As for Recommendation 3 primary rule.
6.2	Secondary rule – deny deduction in payer jurisdiction.	As for Recommendation 3 primary rule.	As for Recommendation 3 primary rule.
7	Recommendation 7		
7.1	Deny deduction in both jurisdictions.	As for Recommendation 3 primary rule.	As for Recommendation 3 primary rule.
8	Recommendation 8		
8.1	Deny deduction in payer jurisdiction.	As for Recommendation 1 primary rule.	As for Recommendation 1 primary rule.

Submission point 11A

Submissions are sought on the intended approach to manage the interaction of the OECD's recommendations and New Zealand's withholding tax, transfer pricing and thin capitalisation rules.

Interaction of hybrid rules and the CFC regime

11.12 Recommendation 5.1 as it relates to payments to a reverse hybrid is considered in Chapter 7. Recommendation 5.1 also suggests that countries consider introducing or making changes to their offshore investment regimes in relation to imported mismatches.

11.13 One such change, labelled a "modified hybrid mismatch rule", is set out in paragraphs 29 to 33 of the OECD's Final Report on Action 3: Designing Effective Controlled Foreign Company Rules.⁶² The change suggested is that a payment from one CFC to another should be included in CFC income if it is:

- not included in CFC income of the payee; and
- would have been included in CFC income if the parent jurisdiction (the jurisdiction applying its CFC rules) had classified the entities and the arrangement the same way as the payer or payee jurisdiction.

11.14 A more general issue is the extent to which a New Zealand company applying the CFC rules has to determine attributable foreign income when taking into account the application of the hybrid rules.

KPMG Comment: It is not clear that such a rule is required as we would expect that any such income is passive income and already included as CFC income if the active income ratio is breached.

Submission points 11B

Submissions are sought on:

- the desirability or otherwise of this modified hybrid mismatch rule; and
- the interaction more generally between the CFC rules and the hybrid rules.

Hybrid rules and anti-avoidance

11.15 We propose that the rules would apply before (and therefore would be subject to) the general anti-avoidance provision. This will ensure that the hybrid rules, which generally apply automatically and do not have a purpose requirement,

⁶² OECD (2015), *Designing Effective Controlled Foreign Company Rules, Action 3 – 2015 Final Report*, OECD/G20 Base Erosion and Profit Shifting Project, OECD Publishing, Paris.
<http://dx.doi.org/10.1787/9789264241152-en>

cannot be used for a tax avoidance purpose. It is consistent with the way section BG 1 applies to any other tax provision.

KPMG Comment: See our comments above regarding the effect of the introduction of the hybrid rules, and the potential for changes in other countries, to change the analysis for section BG 1 purposes.

Further, the hybrid rules will themselves become part of New Zealand's domestic law. Perversely, despite the expectation that alternative arrangements would be used, the use of an alternative arrangement which ensures the anti-hybrid rules do not apply would appear to be at risk of section BG 1 applying to that alternative.

We accept that this analysis may be circular and unintended. It should be explicitly dealt with to ensure that a lower tax position for an alternative to a hybrid is not at risk of section BG 1 applying.

- 11.16 If New Zealand implements the OECD recommendations, the UK approach⁶³ of having a specific anti-avoidance provision for its hybrid rules should be adopted. This provision would apply to an arrangement which has a more than merely incidental purpose of reducing taxable income by avoiding the application of either the New Zealand hybrid rules or the equivalent rules in a foreign jurisdiction. Taxable income for this purpose would include income taxable in a foreign jurisdiction as well as New Zealand. This reflects the general purpose and approach of the hybrid rules, which is to counteract the double non-taxation of income without any need to determine which country's revenue has been affected. It may be useful to explicitly state, as the UK does, that in determining whether an arrangement does avoid the application of the rules, reference should be made to the Final Report and any document which replaces or supplements it.

KPMG Comment: See comment above. An intended result is that taxpayers use alternative arrangements. This rule would appear to prevent their use.

We note that this is a black letter law approach. The OECD report would suggest that this is not hybrid avoidance. However, we note the uncertain status of the OECD report for New Zealand statutory interpretation as well as our comments regarding the unprincipled approach taken. Both will make the application of the parliamentary contemplation test uncertain. This may encourage Inland Revenue to take and the Courts to accept such arguments.

We further note that examples of what Officials consider are unacceptable avoidance of the hybrids rules is required to determine whether this proposal is valid.

⁶³ See proposed section 259M of TIOPA 2010 (United Kingdom).

Submission point 11C

Submissions are sought on the proposal to include a hybrid rules-specific anti-avoidance rule.

Legislative design

11.17 The Final Report clearly expects countries to draft domestic legislation implementing the rules, rather than simply incorporating all or some of the Final Report directly into domestic law. Nevertheless, the Report will continue to be an important document in interpreting the legislation, to the extent that interpretation requires an understanding of the purpose of the rules.

11.18 It may be possible or desirable in some areas to legislate broad principles, which could be fleshed out by regulations of some kind. Regulations, or some other form of subsidiary legislation, would have the benefit of being:

- more easily able to be changed than primary legislation;
- more flexible in their form. For example, it would be easier to include detailed examples, and to have extended discussion of the examples, in subsidiary legislation.

11.19 Examples of where some form of subsidiary regulation might be appropriate are:

- fleshing out the imported mismatch rules;
- providing detail on the definition and calculation of dual inclusion income;
- determination of the extent to which CFC taxation can be treated as preventing a D/NI outcome;
- resolution of double taxation outcomes resulting from introduction of the rules in New Zealand or a counterparty country – in this case the Commissioner might be given the power to override the rules where they would otherwise give a double taxation result.

KPMG Comment: See our submissions on the regulation making powers proposed in the Taxation (Business Tax, Exchange of Information and Remedial Matters) Bill and SOPs. The ability to use regulations and determinations needs to be clearly established so that their validity can be tested.

We further note that the status of subsidiary legislation in determining Parliament's contemplation for section BG 1 purposes needs to be clearly established. Taxpayers will not wish to be at risk of following a regulation or determination only for Inland Revenue to argue that the application of the subsidiary legislation is contrary to Parliament's contemplation.

Submission point 11D

Submissions are sought on the legislative design proposals set out above.

General rule for introduction

11.20 The hybrid rules are intended to apply to all payments made after the effective date of the implementing law. This effective date should be far enough in advance to give taxpayers sufficient time to determine the likely impact of the rules and to restructure existing arrangements to avoid any adverse consequences (Final Report, paragraph 311). Since the rules generally apply to arrangements between related parties or within a control group, restructuring arrangements should not be as difficult as it might otherwise be. Furthermore, the result achieved by the rules should not generally be a punitive one, rather it involves the loss of an unintended tax benefit. The Final Report also suggests that the rules should generally take effect from the beginning of a taxpayer's accounting period.

KPMG Comment: See our comments above regarding the intended or otherwise granting of a tax benefit and the double taxation effects of denying deductions and applying withholding tax.

See also KPMG's previous submissions on proposals to alter the related party NRWT rules. Alternative arrangements are unlikely to be quickly implemented or readily apparent.

11.21 The Board of Taxation recommended that the Australian rules come into force with respect to payments made on or after the later of 1 January 2018 or six months after enactment. The UK rules come into force for payments made on or after 1 January 2017, which is approximately eight months after the introduction of the Finance Bill which contained the rules.

11.22 The impact of the proposals will in most cases be able to be established now, by reference to the Final Report. We consider that the period from introduction of the relevant legislation to its enactment should give taxpayers sufficient time to determine the likely impact and accordingly the effective date of the legislation should be its enactment date. In accordance with the OECD recommendation, the provisions would then apply to payments made after a taxpayer's first tax balance date following enactment. This is a similar approach to that taken to the implementation of the NRWT anti-deferral rules,⁶⁴ except that in this case there would be no early implementation for post-enactment transactions.

KPMG Comment: We disagree. The proposals are detailed, complex and broad in their application. The consultation time frame has not allowed for comprehensive consideration. It is by no means certain that they should apply or in what form they should apply. Our comments

⁶⁴ In the Taxation (Annual Rates for 2016–17, Closely Held Companies and Remedial Matters) Bill.

illustrate this conclusion. Grand-parenting and a reasonable delay (post-enactment) for their implementation should be considered.

- 11.23 An alternative approach would be the Australian one (application to all payments made or received a fixed period after enactment), which would have the benefit of giving all taxpayers an identical start date for applying the rules.

Submission points 11E

Submissions are sought on whether there are any special circumstances that would warrant departing from the general proposition of no grand-parenting, and whether the proposed effective date is appropriate.

Co-ordination with other countries

- 11.24 Rules will also be needed to deal with different implementation dates by different countries. Issues are raised in particular if one country applies an accrual basis of income or expense recognition while the other applies a cash basis.
- 11.25 For example, suppose a hybrid payment in respect of a hybrid financial instrument is made by A Co to B Co, and Country A does not have the hybrid rules but Country B does. B Co will be taxable on the payment. If Country A then introduces the rules, then A Co will be denied a deduction for its payment under the primary rule and B Co will no longer be taxable on that payment. If both companies are on a cash basis and have the same tax accounting period, there is no issue. However, suppose that the two companies have different tax years. Consider B Co's tax year during which the Country A hybrid rules take effect. Country B will need to tax payments received by B Co during the part of its tax year before the start of A Co's tax year, and not tax those received afterwards.
- 11.26 Example 2.3 in the Final Report concerns a transitional situation where a payer of a deductible/exempt dividend is subject to the primary rule in year two, but in year three the payee country introduces a domestic dividend exemption denial rule, in accordance with Recommendation 2.1. The payer is claiming a deduction on an accrual basis, but the payee is recognising income on a payments basis. The effect of the introduction of the exemption denial rule in the payee country is that the payer is entitled to a full deduction in year 3, and the payee is taxable on the portion of the payment for which a deduction has been claimed. That is less than the entire payment, since a portion of the payment was accrued by the payer in year 2, and was non-deductible due to the primary rule.⁶⁵

⁶⁵ Note that there is an error in the example. B Co's year 4 interest deduction for tax purposes should be 75 and its year 4 taxable income should be 25.

KPMG Comment: We note that this appears to be the only section where the document has any concern for double taxation. The same concern should be applied to the rest of the proposals.

Submission point 11F

Submissions are sought on any particular situations that might require particular care to avoid double taxation, beyond those set out here and in the Final Report. It may be desirable to provide some flexibility for the Commissioner to make discretionary adjustments where co-ordination issues mean that the application of the rules in two countries gives rise to double taxation.

CHAPTER 12

Key definitions

12.1 The last three recommendations in the Final Report are about definitions. Most of the definitions are straightforward and they should be adopted so far as necessary. In this Chapter the question of how some significant definitions might be incorporated into New Zealand law is considered.

Financial instrument

12.2 Recommendation 1 applies primarily to “financial instruments”. Recommendation 1.2(c) is that countries treat as a financial instrument any arrangement where one person provides money to another in consideration for a financing or equity return.

12.3 In New Zealand a financial instrument would include a financial arrangement as defined in subpart EW. However, a number of the exclusions from the financial arrangement definition would not apply.

- Given the purpose of the hybrid rules, a financial instrument would include shares in a company, as defined for tax purposes. It would not include an interest in a vehicle treated as fiscally transparent for New Zealand purposes, such as a partnership or look-through company.
- Variable principal debt instruments would be included.
- The definition should also include annuities, farm out arrangements, share lending arrangements and livestock or bloodstock hire purchases, since all of these seem to have some financing component, and could be entered into in a commercial context.

12.4 It is proposed that the remaining excepted financial arrangements would not be financial instruments. This means that operating leases would be outside the definition, while finance leases and hire purchase agreements would be within it.

Structured arrangement

12.5 The definition of a “structured arrangement” is set out in Recommendation 10 of the Final Report, and discussed in some detail. The core definition is that it is an arrangement where either:

- the hybrid mismatch is priced into the terms of the arrangement; or
- the facts and circumstances indicate that it has been designed to produce a hybrid mismatch.

- 12.6 Facts and circumstances which would be taken into account in determining whether or not an arrangement has been designed to produce a hybrid mismatch would include whether or not the arrangement:
- incorporates a term, step or transaction used to create a hybrid mismatch;
 - is marketed as a tax advantage product where some or all of the tax advantage derives from a hybrid mismatch;
 - is marketed primarily to investors in a country where the hybrid mismatch arises;
 - contains features that alter the terms if a hybrid mismatch does not exist, for example, a tax gross-up provision; or
 - produces a negative return absent the hybrid mismatch.
- 12.7 To incorporate this definition into New Zealand law, it is proposed to use the existing “arrangement” definition, and to define a structured arrangement as one where either:
- the hybrid mismatch is priced into the terms of the arrangement; or
 - the arrangement has a purpose or effect of producing a hybrid mismatch.
- 12.8 As with the existing *Ben Nevis* factors which apply in the context of section BG 1, we propose that the list of factors provided in the Final Report be reproduced in guidance, rather than being legislated. This is also the approach recommended by the Australian Board of Taxation.

KPMG comment: A definition drafted per the second bullet point in 12.7 does not duplicate the facts and circumstances tests in 12.6. As Officials are aware, guidance is not binding on the Commissioner. It is therefore possible for an arrangement which is analysed as producing a hybrid mis-match to be characterised as a structured arrangement.

The example we have used is of an investment in an Australian unit trust which is a FIF and to which the FDR method is applied. Using the analysis in paragraphs 5.48 to 5.51:

- *Distributions from the unit trust (which are dividends) are not taxable in New Zealand;*
- *Distributions from the unit trust are deductible to the unit trust (a dividend from a company in New Zealand terms). The unit trust does not pay tax on such distributions. It withholds tax payable by the investor.*

This is a hybrid mis-match: a D/NI result. It has that purpose or effect. Although there would not normally be any of the facts and circumstances described in 12.6, it would appear to be a structured arrangement.

Related persons

- 12.9 Recommendation 11.1(a) is that two persons are related if they are in the same “control group” (considered below) or:
- one of the persons has a 25 percent or greater interest in the second; or
 - a third person holds a 25 percent or greater interest in both.
- 12.10 For this purpose, a person who acts together with another person in respect of the ownership or control of any investment in another person will be treated as also owning that other person’s investment.
- 12.11 Two persons will be treated as acting together in respect of ownership or control of an investment if:
- they are family members. A person’s family members are:
 - persons who are within two degrees of relationship of the person, and those persons’ spouses;
 - the person’s spouse;
 - persons who are within two degrees of relationship of the first person’s spouse;
 - one regularly acts in accordance with the wishes of the other;
 - they have entered into an arrangement that has a material effect on the value or control of the investment; and
 - the ownership or control of the investment is managed by the same person or group of persons.
- 12.12 An investment in an entity can be a voting interest or an equity interest or both. A voting interest can apply to non-corporate as well as corporate entities, and is a right to participate in decision making concerning distributions, changes in the person’s constitution or the appointment of a director, broadly defined so that includes the persons who have management and control of an entity.
- 12.13 A look-through test applies to trace interests through interposed entities.
- 12.14 This approach is similar to that taken to determining whether or not two companies, two natural persons, and a company and a person other than a company, are associated under subpart YB 2 to YB 4 and YB 13 and YB 14, subject to the fact that for two companies, the test generally requires a 50 percent common ownership.⁶⁶ However, the application to trusts and partnerships seems somewhat different. While it would make sense to build so far as possible on existing definitions, it is likely to be preferable to do so by using a stand-alone definition which combines existing concepts plus the modifications necessary to ensure that New Zealand’s hybrid regime has the same scope as others enacted in accordance with Action 2.

⁶⁶ Also, the definition of a family member seems somewhat broader than the definition of a relative in section YA 1. For example, a person’s sister’s spouse is a family member but not a relative. We propose that the broader definition be used in this context.

KPMG Comment: It is not clear that the compliance difficulties that will arise from an extended definition of related persons and control groups have been adequately considered.

Control group

12.15 Two persons will be in a control group if:

- they are consolidated for accounting purposes, either under IFRS or applicable GAAP;
- one of them effectively controls the other, or a single person effectively controls both;
- one of them has a 50 percent or greater investment in the other, or a single person has a 50 percent or greater ownership of both; or
- they are associated enterprises under Article 9 of the OECD Model Treaty, which defines when transfer pricing adjustments may be made. The Final Report states that countries should apply their own transfer pricing thresholds for this purpose, so that if transactions between two entities are subject to transfer pricing adjustments under domestic law, they are in a control group for purposes of the hybrid rules (Final Report, paragraph 367).

12.16 In determining control and ownership, the same rules apply as those in determining ownership interests for purposes of the related person definition. In particular, interests of persons who act together in respect of their interests, or are treated as doing so, will be aggregated as set out in paragraph **Error! Reference source not found.** However, control is clearly a broader concept than ownership. For example, a substantial shareholder in a widely held company may have effective control over the appointment of directors, despite not having 50 percent of the rights to appoint the directors (Final Report, paragraph 364).

12.17 In the New Zealand context, in addition to the issues considered above in relation to the related person definition:

- consideration will need to be given to whether the existing reference to “control by any other means” in section YB 2(3) would be interpreted by New Zealand’s courts in a manner consistent with its interpretation in the Final Report. If not, a separate definition may be required;
- in accordance with the Final Report, two entities will be in a control group if they are associated persons for purposes of the transfer pricing provisions in subpart GC.

Payment

12.18 “Payment” includes non-monetary flows, such as a transfer of shares or any other asset. It includes not only things convertible into money, but also anything that would be paid for if provided at arm’s length. In New Zealand terms it would be covered by the definition of “money” which applies for purposes of the financial arrangement rules.

Submission point 12

Submissions are sought on any aspects of the OECD’s recommended definitions and how they could be adopted by New Zealand.